

# 外徑車刀

External Turning Tools



Since 1976



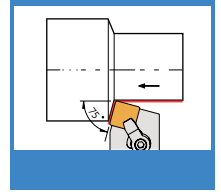
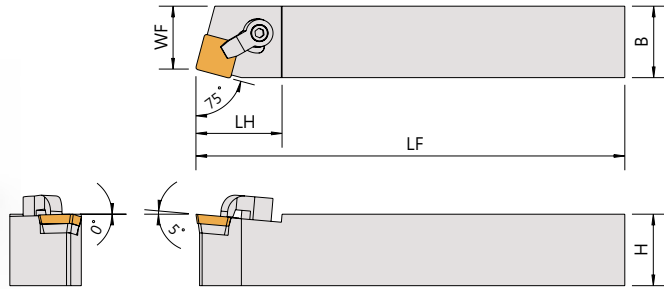
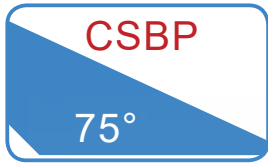

Order No.	Insert	Dimensions(mm)					Parts				Wrench
Right / Left		柄高	柄寬	長度	頭長	工作寬度					
		H	B	LF	LH	WF					
CSBPR/L-2020K12	SPMN1203	20	20	125	30	17	SMS-421	CSF3010	CP50-22	CS7-6024	LW030
CSBPR/L-2525M12		25	25	150	30	22	SMS-421	CSF3010	CP50-22	CS7-6024	LW030

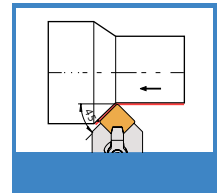
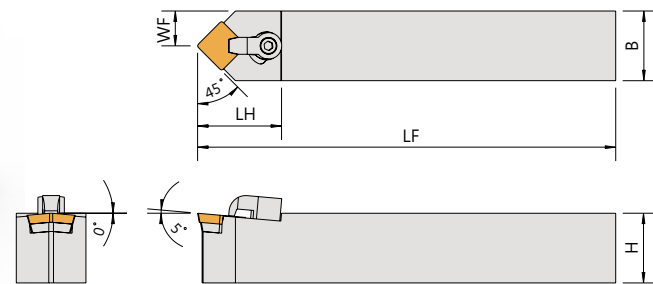
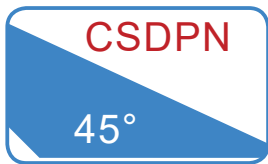

Order No.	Insert	Dimensions(mm)					Parts				Wrench
Right / Left		柄高	柄寬	長度	頭長	工作寬度					
		H	B	LF	LH	WF					
CSDPN-2020K12	SPMN1203	20	20	125	30	10	SMS-421	CSF3010	CP50-22	CS7-6024	LW030
CSDPN-2525M12		25	25	150	30	12.5	SMS-421	CSF3010	CP50-22	CS7-6024	LW030

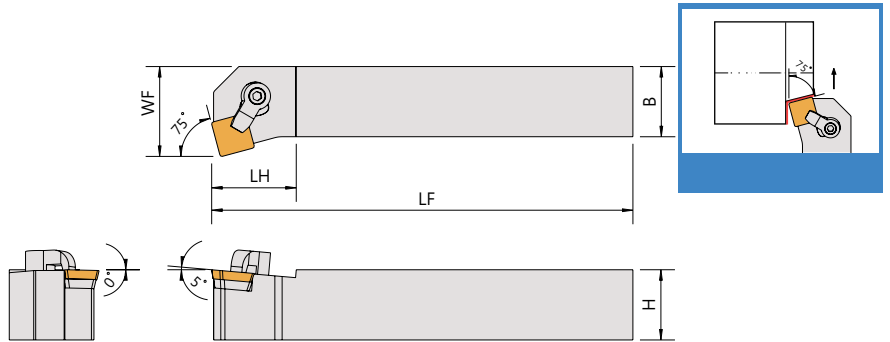
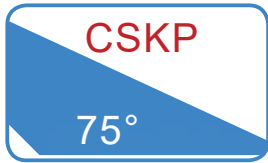

Order No.	Insert	Dimensions(mm)					Parts				Wrench
		柄高 H	柄寬 B	長度 LF	頭長 LH	工作寬度 WF					
CSKPR/L-2020K09	SPMN0903	20	20	125	26	25	-	-	CP50-21	CS7-5015	LW025
CSKPR/L-2020K12	SPMN1203	20	20	125	26	25	SMS-421	CSF3010	CP50-22	CS7-6024	LW030
CSKPR/L-2525M12		25	25	150	26	32	SMS-421	CSF3010	CP50-22	CS7-6024	LW030

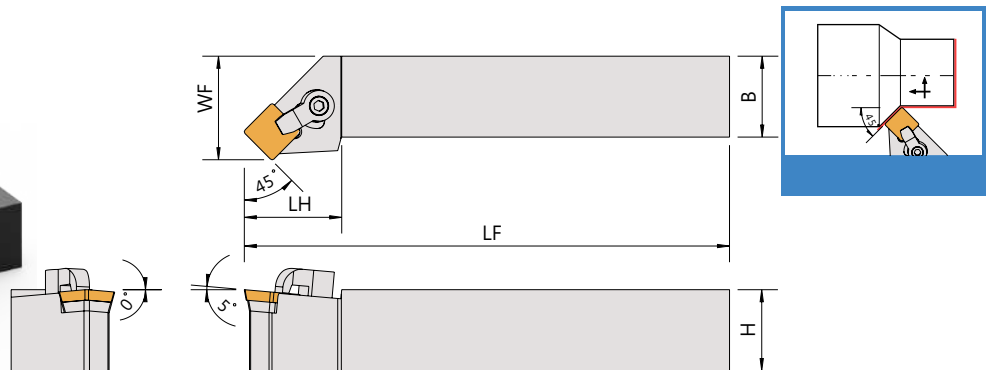
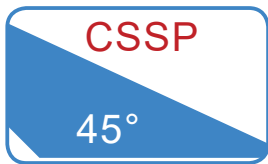

Order No.	Insert	Dimensions(mm)					Parts				Wrench
		柄高 H	柄寬 B	長度 LF	頭長 LH	工作寬度 WF					
CSSPR/L-2020K12	SPMN1203	20	20	125	30	25	SMS-421	CSF3010	CP50-22	CS7-6024	LW030
CSSPR/L-2525M12		25	25	150	30	32	SMS-421	CSF3010	CP50-22	CS7-6024	LW030

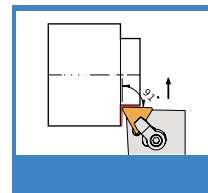
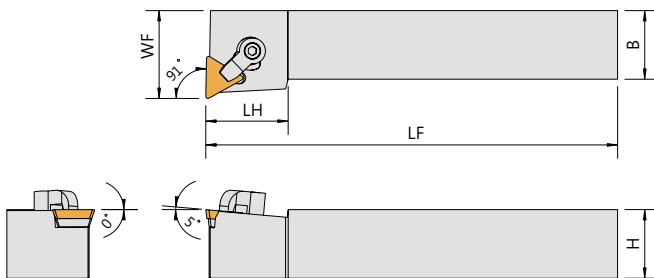
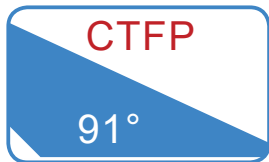

Order No.	Insert	Dimensions(mm)					Parts				Wrench
		柄高 H	柄寬 B	長度 LF	頭長 LH	工作寬度 WF					
CTFPR/L-1616H11	TPMN1103	16	16	100	20	20	-	-	CP50-21	CS7-5015	LW025
CTFPR/L-2020K16	TPMN1603	20	20	125	30	25	SMT-321	CS20045	CP50-22	CS7-6024	LW030
CTFPR/L-2525M16		25	25	150	30	32	SMT-321	CS20045	CP50-22	CS7-6024	LW030

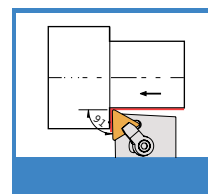
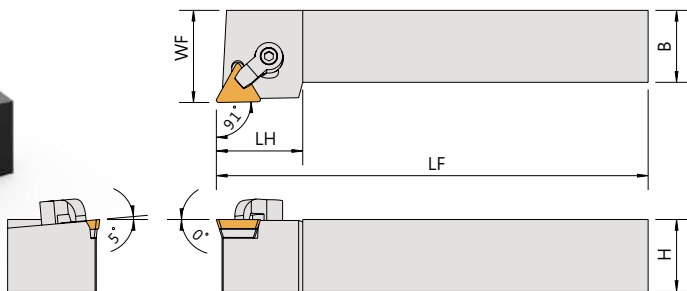
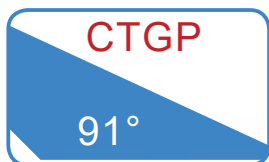

Order No.	Insert	Dimensions(mm)					Parts				Wrench
		柄高 H	柄寬 B	長度 LF	頭長 LH	工作寬度 WF					
CTGPR/L-1212F11	TPMN1103	12	12	80	20	16	-	-	CP50-21	CS7-5015	LW025
CTGPR/L-1616H11		16	16	100	20	20	-	-	CP50-21	CS7-5015	LW025
CTGPR/L-2020K16	TPMN1603	20	20	125	30	25	SMT-321	CS20045	CP50-22	CS7-6024	LW030
CTGPR/L-2525M16		25	25	150	30	32	SMT-321	CS20045	CP50-22	CS7-6024	LW030

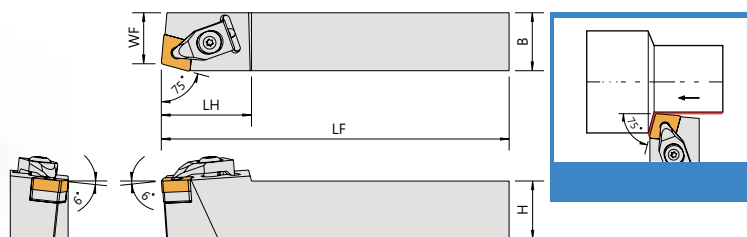
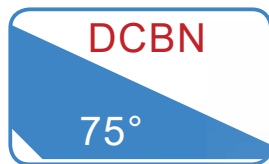

Order No.	Insert	Dimensions(mm)					Parts					Wrench
		柄高 H	柄寬 B	長度 LF	頭長 LH	工作寬度 WF						
DCBNR/L2020K12	CNMG1204	20	20	125	37	17	SMC-432	CSF4010	CP-D4	SP0816	CSB0620T	TL20
DCBNR/L2525M12		25	25	150	37	22	SMC-432	CSF4010	CP-D4	SP0816	CSB0620T	TL20
DCBNR/L3232P12		32	32	170	37	22	SMC-432	CSF4010	CP-D4	SP0816	CSB0620T	TL20

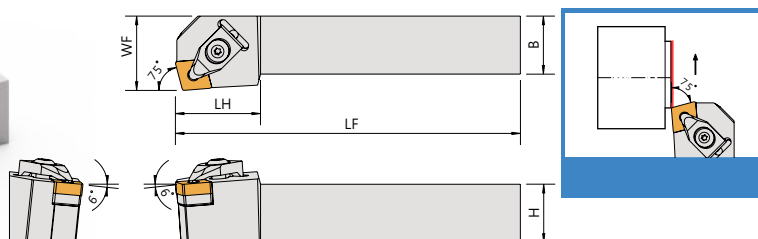
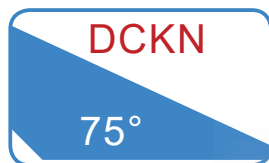

Order No.	Insert	Dimensions(mm)					Parts					Wrench
		柄高 H	柄寬 B	長度 LF	頭長 LH	工作寬度 WF						
DCKNR/L2020K12	CNMG1204	20	20	125	37	25	SMC-432	CSF4010	CP-D4	SP0816	CSB0620T	TL20
DCKNR/L2525M12		25	25	150	37	32	SMC-432	CSF4010	CP-D4	SP0816	CSB0620T	TL20
DCKNR/L3232P12		32	32	170	37	32	SMC-432	CSF4010	CP-D4	SP0816	CSB0620T	TL20

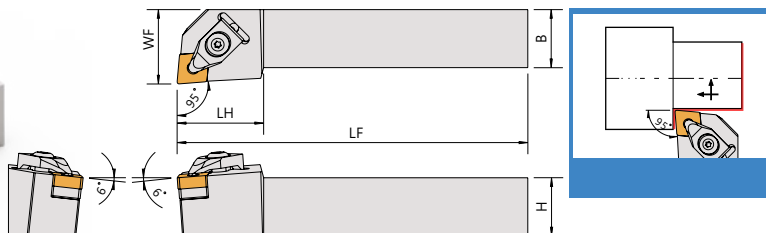
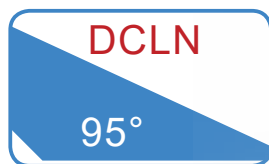

Order No.	Insert	Dimensions(mm)					Parts					Wrench
		柄高 H	柄寬 B	長度 LF	頭長 LH	工作寬度 WF						
DCLNR/L1616H09	CNMG0903	16	16	100	33	20	SMC-322	CSF3008	CP-D2	SP0612	CSB0415T	TL15
DCLNR/L2020K09		20	20	125	30	25	SMC-322	CSF3008	CP-D2	SP0612	CSB0415T	TL15
DCLNR/L2525M09		25	25	150	30	32	SMC-322	CSF3008	CP-D2	SP0612	CSB0415T	TL15
DCLNR/L2020K12	CNMG1204	20	20	125	40	25	SMC-432	CSF4010	CP-D4	SP0816	CSB0620T	TL20
DCLNR/L2525M12		25	25	150	36	32	SMC-432	CSF4010	CP-D4	SP0816	CSB0620T	TL20
DCLNR/L3232P12		32	32	170	36	32	SMC-432	CSF4010	CP-D4	SP0816	CSB0620T	TL20

**DDJN**  
93°

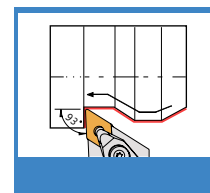
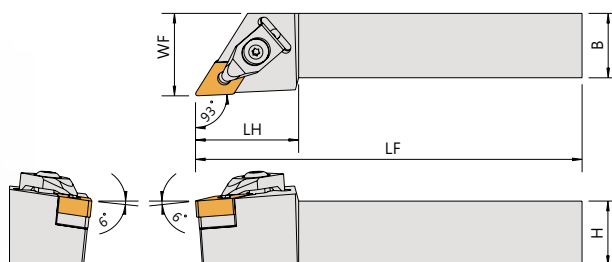

Order No.	Insert	Dimensions(mm)					Parts					Wrench
		柄高	柄寬	長度	頭長	工作寬度						
Right / Left		H	B	LF	LH	WF						
DDJNR/L1616H11	DNMG1104	16	16	100	36	20	SMD-343	CSA40075	CP-D2	SP0612	CSB0415T	TL15
DDJNR/L2020K11		20	20	125	36	25	SMD-343	CSA40075	CP-D2	SP0612	CSB0415T	TL15
DDJNR/L2525M11		25	25	150	36	32	SMD-343	CSA40075	CP-D2	SP0612	CSB0415T	TL15
DDJNR/L2020K15	DNMG1504-SMD463 DNMG1506-SMD443	20	20	125	43	25	SMD-4X3	CSF4010	CP-D4	SP0816	CSB0620T	TL20
DDJNR/L2525M15		25	25	150	43	32	SMD-4X3	CSF4010	CP-D4	SP0816	CSB0620T	TL20
DDJNR/L3232P15		32	32	170	43	40	SMD-4X3	CSF4010	CP-D4	SP0816	CSB0620T	TL20

**DDHN**  
107.5°

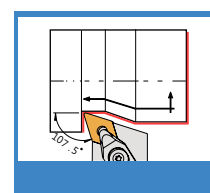
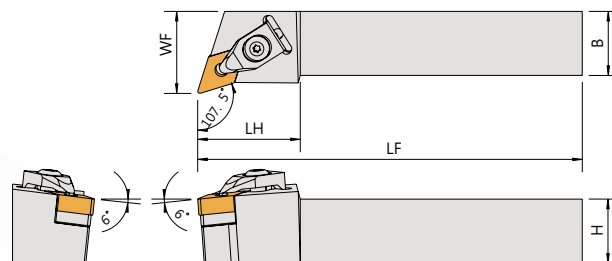

Order No.	Insert	Dimensions(mm)					Parts					Wrench
		柄高	柄寬	長度	頭長	工作寬度						
Right / Left		H	B	LF	LH	WF						
DDHNR/L2020K15	DNMG1504-SMD463 DNMG1506-SMD443	20	20	125	35	25	SMD-4X3	CSF4010	CP-D4	SP0816	CSB0620T	TL20
DDHNR/L2525M15		25	25	150	35	32	SMD-4X3	CSF4010	CP-D4	SP0816	CSB0620T	TL20

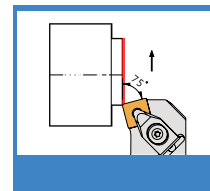
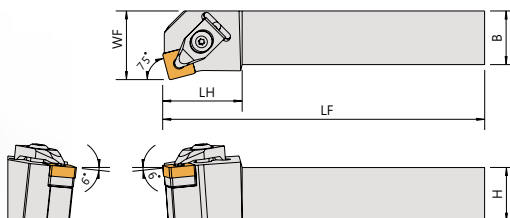
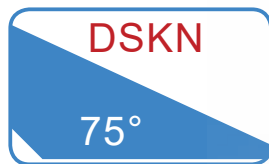

Order No.	Insert	Dimensions(mm)					Parts					Wrench
		柄高 H	柄寬 B	長度 LF	頭長 LH	工作寬度 WF						
DSKNR/L2020K12	SNMG1204	20	20	125	40	25	SMS-432	CSF4010	CP-D4	SP0816	CSB0620T	TL20
DSKNR/L2525M12		25	25	150	36	32	SMS-432	CSF4010	CP-D4	SP0816	CSB0620T	TL20
DSKNR/L3232P12		32	32	170	36	40	SMS-432	CSF4010	CP-D4	SP0816	CSB0620T	TL20

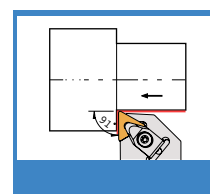
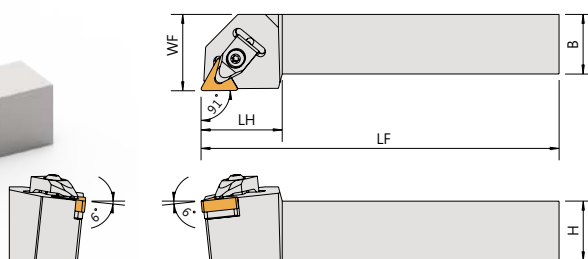
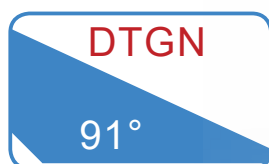

Order No.	Insert	Dimensions(mm)					Parts					Wrench
		柄高 H	柄寬 B	長度 LF	頭長 LH	工作寬度 WF						
DTGNR/L1616H16	TNMG1604	16	16	100	33	20	SMT-323	CSA40075	CP-D2	SP0612	CSB0415T	TL15
DTGNR/L2020K16		20	20	125	33	25	SMT-323	CSA40075	CP-D2	SP0612	CSB0415T	TL15
DTGNR/L2525M16		25	25	150	33	32	SMT-323	CSA40075	CP-D2	SP0612	CSB0415T	TL15

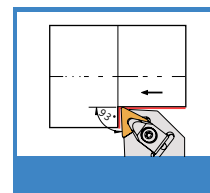
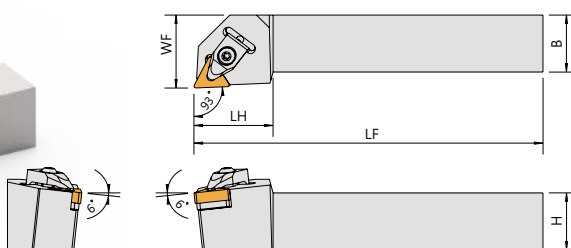
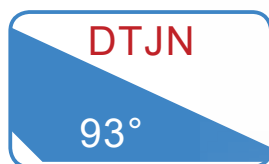

Order No.	Insert	Dimensions(mm)					Parts					Wrench
		柄高 H	柄寬 B	長度 LF	頭長 LH	工作寬度 WF						
DTJNR/L1616H16	TNMG1604	16	16	100	33	20	SMT-323	CSA40075	CP-D2	SP0612	CSB0415T	TL15
DTJNR/L2020K16		20	20	125	33	25	SMT-323	CSA40075	CP-D2	SP0612	CSB0415T	TL15
DTJNR/L2525M16		25	25	150	33	32	SMT-323	CSA40075	CP-D2	SP0612	CSB0415T	TL15



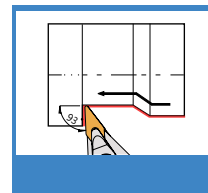
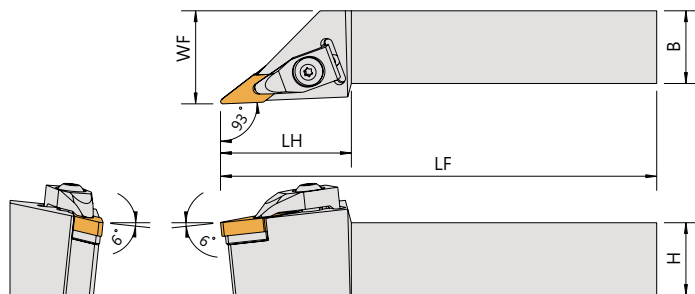
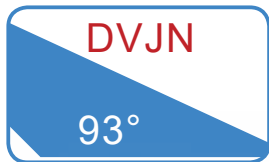

Order No.	Insert	Dimensions(mm)					Parts					Wrench
		柄高	柄寬	長度	頭長	工作寬度						
Right / Left		H	B	LF	LH	WF						
DVJNR/L2020K16	VNMG1604	20	20	125	50	25	SMV-322	CSA40075	CP-D3	SP0816	CSB0620T	TL20
DVJNR/L2525M16		25	25	150	46	32	SMV-322	CSA40075	CP-D3	SP0816	CSB0620T	TL20

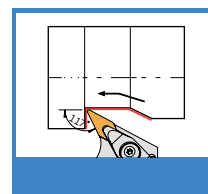
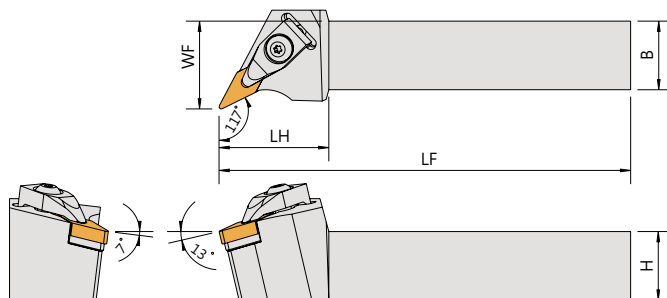
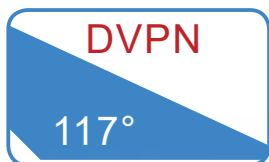

Order No.	Insert	Dimensions(mm)					Parts					Wrench
		柄高	柄寬	長度	頭長	工作寬度						
Right / Left		H	B	LF	LH	WF						
DVPNR/L2020K16	VNMG1604	20	20	125	43	25	SMV-322	CSA40075	CP-D3	SP0816	CSB0620T	TL20
DVPNR/L2525M16		25	25	150	43	32	SMV-322	CSA40075	CP-D3	SP0816	CSB0620T	TL20



**DVVNN**  
72.5°

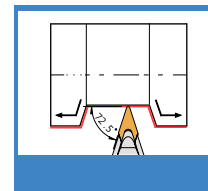
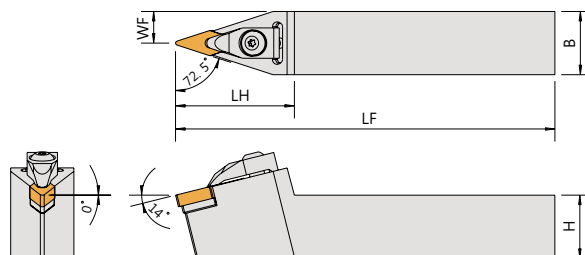

Order No.	Insert	Dimensions(mm)					Parts					Wrench
		柄高	柄寬	長度	頭長	工作寬度						
Right / Left		H	B	LF	LH	WF						
DVVNN2020K16	VNMG1604	20	20	125	47	10	SMV-322	CSA40075	CP-D3	SP0816	CSB0620T	TL20
DVVNN2525M16		25	25	150	47	12.5	SMV-322	CSA40075	CP-D3	SP0816	CSB0620T	TL20

**DWLNR**  
95°

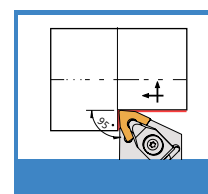
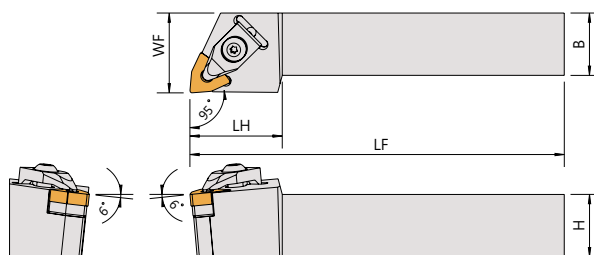

Order No.	Insert	Dimensions(mm)					Parts					Wrench
		柄高	柄寬	長度	頭長	工作寬度						
Right / Left		H	B	LF	LH	WF						
DWLNR/L1616H06	WNMG0604	16	16	100	33	20	SMW-321	CSA40075	CP-D2	SP0612	CSB0415T	TL15
DWLNR/L2020K06		20	20	125	33	25	SMW-321	CSA40075	CP-D2	SP0612	CSB0415T	TL15
DWLNR/L2525M06		25	25	150	33	32	SMW-321	CSA40075	CP-D2	SP0612	CSB0415T	TL15
DWLNR/L2020K08	WNMG0804	20	20	125	40	25	SMW-432	CSF4010	CP-D4	SP0816	CSB0620T	TL20
DWLNR/L2525M08		25	25	150	40	32	SMW-432	CSF4010	CP-D4	SP0816	CSB0620T	TL20
DWLNR/L3232P08		32	32	170	40	32	SMW-432	CSF4010	CP-D4	SP0816	CSB0620T	TL20

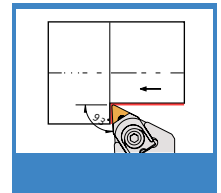
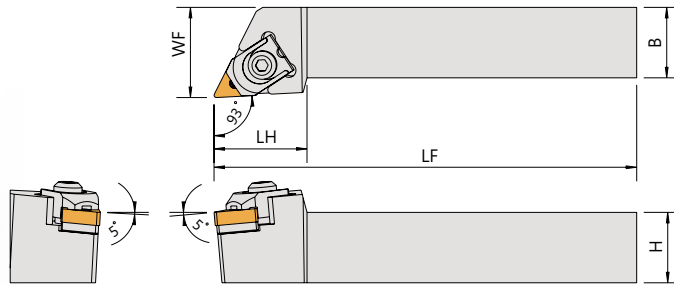
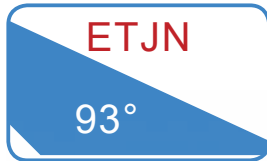

Order No.	Insert	Dimensions(mm)					Parts					Wrench	
		柄高 H	柄寬 B	長度 LF	頭長 LH	工作寬度 WF							
ETJNR/L-2020K16	TNMG1604	20	20	125	32	25	SMT-322	LCS-513	CPE-T16	CSE8026	ER31	LW025	LW050
ETJNR/L-2525M16		25	25	150	32	32	SMT-322	LCS-513	CPE-T16	CSE8026	ER31	LW025	LW050
ETJNR/L-3232P16		32	32	170	32	40	SMT-322	LCS-513	CPE-T16	CSE8026	ER31	LW025	LW050
ETJNR/L-2020-33		20	20	125	32	25	SMT-323	LCS-415 LCS-4B	CPE-T16	CSE8026	ER31	LW025	LW050
ETJNR/L-2525-33		25	25	150	32	32	SMT-323	LCS-420 LCS-4B	CPE-T16	CSE8026	ER31	LW025	LW050

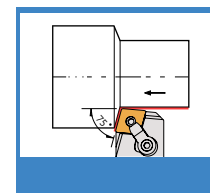
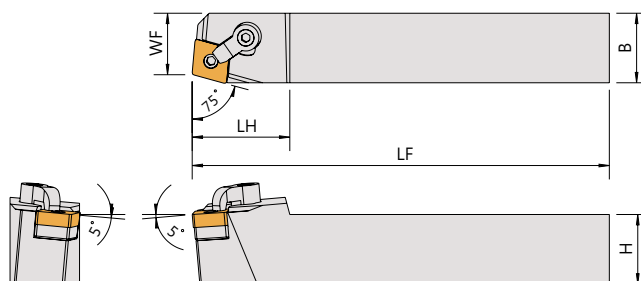
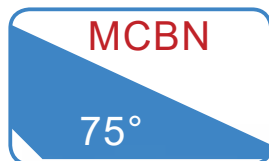

Order No.	Insert	Dimensions(mm)					Parts				Wrench
		柄高 H	柄寬 B	長度 LF	頭長 LH	工作寬度 WF					
MCBNR/L-2020K12	CNMG1204	20	20	125	30	17	SMC-432	LCS-617	CP50-22	CS7-6030	LW030
MCBNR/L-2525M12		25	25	150	30	22	SMC-432	LCS-617	CP50-22	CS7-6030	LW030
MCBNR/L-3232P12		32	32	170	40	27	SMC-432	LCS-617	CP50-22	CS7-6030	LW030
MCBNR/L-2525M16	CNMG1606	25	25	150	30	22	SMC-533	LCS-822	CP50-22	CS7-6030	LW030
MCBNR/L-3232P16		32	32	170	40	27	SMC-533	LCS-822	CP50-22	CS7-6030	LW030
MCBNR/L-3232P19	CNMG1906	32	32	170	40	27	SMC-633	LCS-1022	CP50-29	CS7-8030	LW040

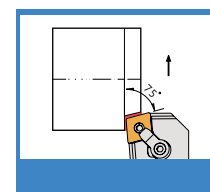
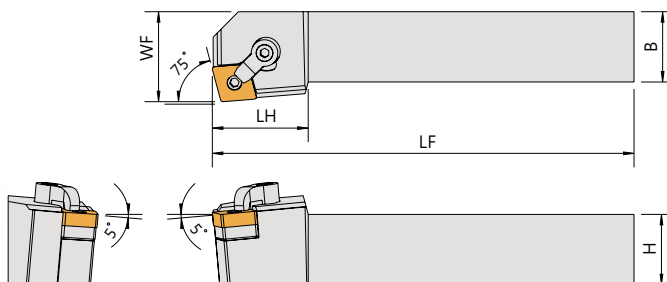
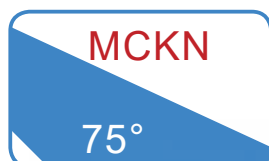

Order No.	Insert	Dimensions(mm)					Parts				Wrench
		柄高 H	柄寬 B	長度 LF	頭長 LH	工作寬度 WF					
MCKNR/L-2020K12	CNMG1204	20	20	125	37	25	SMC-432	LCS-617	CP50-22	CS7-6030	LW030
MCKNR/L-2525M12		25	25	150	34	32	SMC-432	LCS-617	CP50-22	CS7-6030	LW030
MCKNR/L-3225P12		32	25	170	34	32	SMC-432	LCS-617	CP50-22	CS7-6030	LW030
MCKNR/L-3232P12		32	32	170	40	40	SMC-432	LCS-617	CP50-22	CS7-6030	LW030

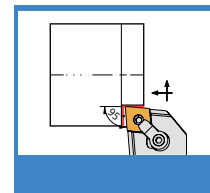
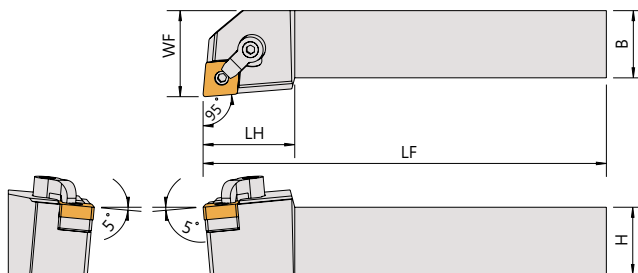
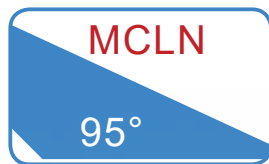

Order No.	Insert	Dimensions(mm)					Parts					Wrench
		柄高 H	柄寬 B	長度 LF	頭長 LH	工作寬度 WF						
MCLNR/L-1616H12	CNMG1204	16	16	100	33	20	SMC-432	LCS-617	CP50-22	CS7-6024	LW030	
MCLNR/L-2020K12		20	20	125	33	25	SMC-432	LCS-617	CP50-22	CS7-6030	LW030	
MCLNR/L-2525M12		25	25	150	33	32	SMC-432	LCS-617	CP50-22	CS7-6030	LW030	
MCLNR/L-3225P12		32	25	170	33	32	SMC-432	LCS-617	CP50-22	CS7-6030	LW030	
MCLNR/L-3232P12		32	32	170	33	40	SMC-432	LCS-617	CP50-22	CS7-6030	LW030	
MCLNR/L-2525M16	CNMG1606	25	25	150	33	32	SMC-533	LCS-0822	CP50-22	CS7-6030	LW030	
MCLNR/L-3225P16		32	25	170	33	32	SMC-533	LCS-0822	CP50-22	CS7-6030	LW030	
MCLNR/L-3232P16		32	32	170	33	40	SMC-533	LCS-0822	CP50-22	CS7-6030	LW030	
MCLNR/L-4040S16		40	40	250	38	50	SMC-533	LCS-0822	CP50-22	CS7-6030	LW030	
MCLNR/L-2525M19	CNMG1906	25	25	150	40	32	SMC-633	LC S-1022	CP50-29	CS7-8030	LW040	
MCLNR/L-3225P19		32	25	170	40	32	SMC-633	LCS-1022	CP50-29	CS7-8030	LW040	
MCLNR/L-3232P19		32	32	170	40	40	SMC-633	LCS-1022	CP50-29	CS7-8030	LW040	
MCLNR/L-4040S19		40	40	250	38	50	SMC-633	LCS-1022	CP50-29	CS7-8030	LW040	

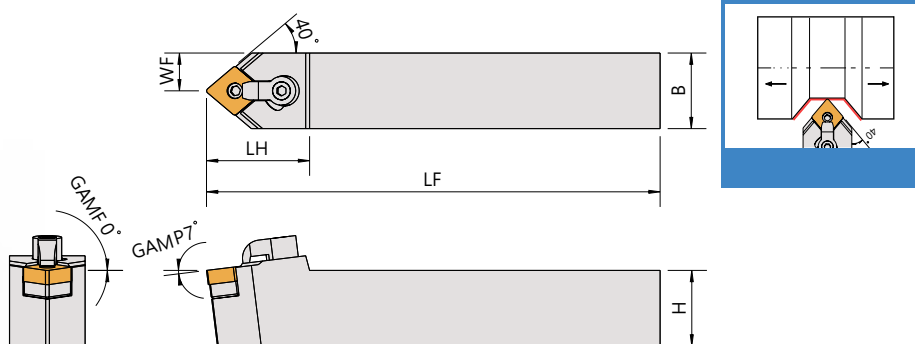
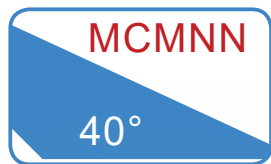

Order No.	Insert	Dimensions(mm)					Parts				Wrench
Right / Left		柄高	柄寬	長度	頭長	工作寬度					
		H	B	LF	LH	WF					
MCMNN-2020K12	CNMG1204	20	20	125	34	10	SMC-432	LCS-617	CP50-22	CS7-6030	LW030
MCMNN-2525M12		25	25	150	34	12.5	SMC-432	LCS-617	CP50-22	CS7-6030	LW030
MCMNN-2525M16	CNMG1606	25	25	150	37	12.5	SMC-533	LCS-0822	CP50-22	CS7-6030	LW030
MCMNN-3225P12	CNMG1204	32	25	170	34	12.5	SMC-432	LCS-617	CP50-22	CS7-6030	LW030
MCMNN-3232P12		32	32	170	34	16	SMC-432	LCS-617	CP50-22	CS7-6030	LW030
MCMNN-3232P16	CNMG1606	32	32	170	40	16	SMC-533	LCS-0822	CP50-22	CS7-6030	LW030
MCMNN-3232P-19	CNMG1906	32	32	170	40	16	SMC-633	LCS-1022	CP50-29	CS7-8030	LW040

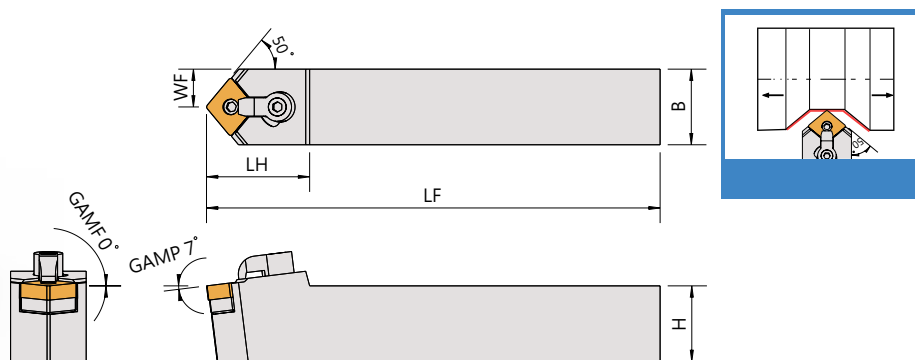
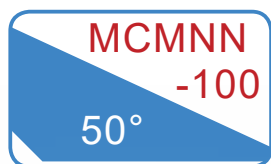

Order No.	Insert	Dimensions(mm)					Parts				Wrench
Right / Left		柄高	柄寬	長度	頭長	工作寬度					
		H	B	LF	LH	WF					
MCMNN-2020K12-100	CNMG1204	20	20	125	34	10	SMC-432	LCS-617	CP50-22	CS7-6030	LW030
MCMNN-2525M12-100		25	25	150	34	12.5	SMC-432	LCS-617	CP50-22	CS7-6030	LW030
MCMNN-2525M16-100	CNMG1606	25	25	150	37	12.5	SMC-533	LCS-0822	CP50-22	CS7-6030	LW030
MCMNN-3225P12-100	CNMG1204	32	25	170	34	12.5	SMC-432	LCS-617	CP50-22	CS7-6030	LW030
MCMNN-3232P12-100		32	32	170	34	16	SMC-432	LCS-617	CP50-22	CS7-6030	LW030
MCMNN-3232P16-100	CNMG1606	32	32	170	40	16	SMC-533	LCS-0822	CP50-22	CS7-6030	LW030
MCMNN-3232P19-100	CNMG1906	32	32	170	40	16	SMC-633	LCS-1022	CP50-29	CS7-8030	LW040

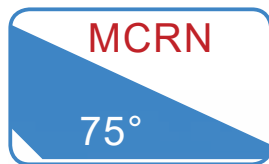

MCRN

75°

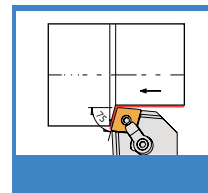
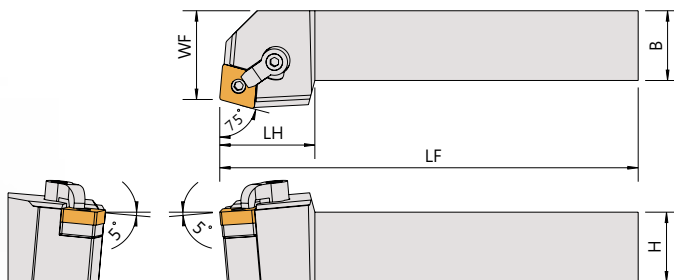

Order No.	Insert	Dimensions(mm)					Parts				Wrench
		柄高 H	柄寬 B	長度 LF	頭長 LH	工作寬度 WF					
MCRNR/L-2020K12	CNMG1204	20	20	125	37	22	SMC-432	LCS-617	CP50-22	CS7-6030	LW030
MCRNR/L-2525M12		25	25	150	34	27	SMC-432	LCS-617	CP50-22	CS7-6030	LW030
MCRNR/L-3225P12		32	25	170	34	27	SMC-432	LCS-617	CP50-22	CS7-6030	LW030
MCRNR/L-3232P12		32	32	170	40	35	SMC-432	LCS-617	CP50-22	CS7-6030	LW030
MCRNR/L-3232P16	CNMG1606	32	32	170	40	35	SMC-533	LCS-822	CP50-22	CS7-6030	LW030
MCRNR/L-3232P19	CNMG1906	32	32	170	40	35	SMC-633	LCS-1022	CP50-29	CS7-8030	LW040

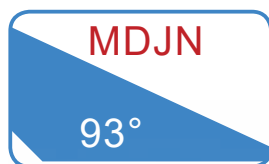

MDJN

93°

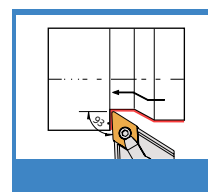
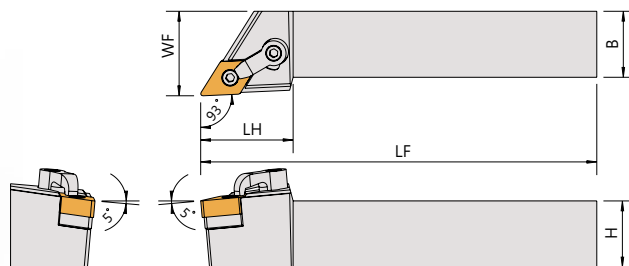

Order No.	Insert	Dimensions(mm)					Parts				Wrench
		柄高 H	柄寬 B	長度 LF	頭長 LH	工作寬度 WF					
MDJNR/L-2020K15	DNMG1504-SMD463 DNMG1506-SMD443	20	20	125	37	25	SMD-4X3	LCS-619	CP50-24	CS7-6030	LW030
MDJNR/L-2525M15		25	25	150	37	32	SMD-4X3	LCS-619	CP50-24	CS7-6030	LW030
MDJNR/L-3225P15		32	25	170	42	32	SMD-4X3	LCS-619	CP50-24	CS7-6030	LW030
MDJNR/L-3232P15		32	32	170	42	40	SMD-4X3	LCS-619	CP50-24	CS7-6030	LW030

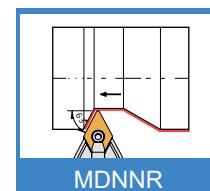
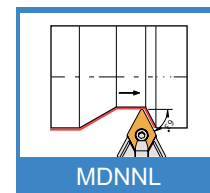
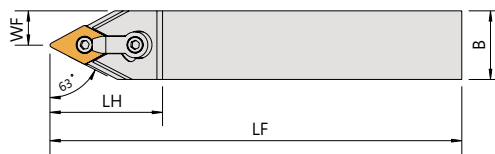
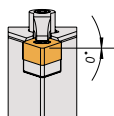
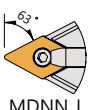
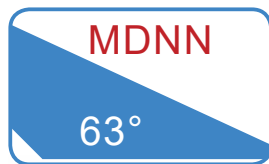

Order No.	Insert	Dimensions(mm)					Parts				Wrench
Right / Left		柄高	柄寬	長度	頭長	工作寬度					
		H	B	LF	LH	WF					
MDNNR/L-2020K15	DNMG1504-SMD463 DNMG1506-SMD443	20	20	125	41	10	SMD-4X3	LCS-619	CP50-24	CS7-6030	LW030
MDNNR/L-2525M15		25	25	150	41	12.5	SMD-4X3	LCS-619	CP50-24	CS7-6030	LW030
MDNNR/L-3225P15		32	25	170	42	12.5	SMD-4X3	LCS-619	CP50-24	CS7-6030	LW030
MDNNR/L-3232P15		32	32	170	43	16	SMD-4X3	LCS-619	CP50-24	CS7-6030	LW030

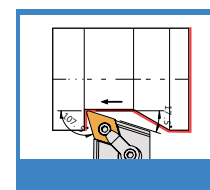
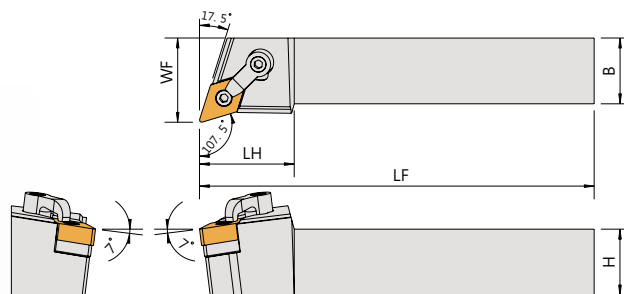
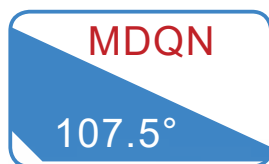

Order No.	Insert	Dimensions(mm)					Parts				Wrench
Right / Left		柄高	柄寬	長度	頭長	工作寬度					
		H	B	LF	LH	WF					
MDQNR/L-2020K15	DNMG1504-SMD463 DNMG1506-SMD443	20	20	125	36	25	SMD-4X3	LCS-619	CP50-24	CS7-6030	LW030
MDQNR/L-2525M15		25	25	150	36	32	SMD-4X3	LCS-619	CP50-24	CS7-6030	LW030
MDQNR/L-3225P15		32	25	170	40	32	SMD-4X3	LCS-619	CP50-24	CS7-6030	LW030
MDQNR/L-3232P15		32	32	170	40	40	SMD-4X3	LCS-619	CP50-24	CS7-6030	LW030



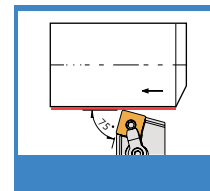
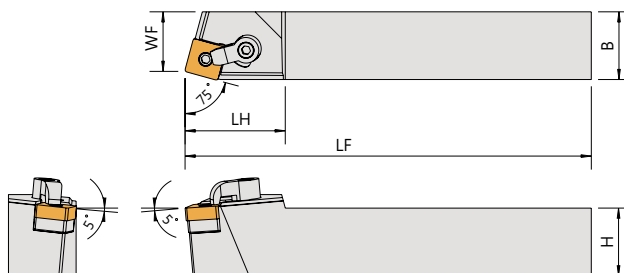
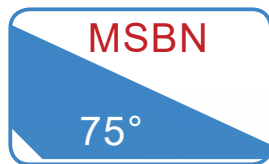

Order No.	Insert	Dimensions(mm)					Parts				Wrench
		柄高 H	柄寬 B	長度 LF	頭長 LH	工作寬度 WF					
MSBNR/L-2020K12	SNMG1204	20	20	125	37	17	SMS-432	LCS-617	CP50-22	CS7-6030	LW030
MSBNR/L-2525M12		25	25	150	37	22	SMS-432	LCS-617	CP50-22	CS7-6030	LW030
MSBNR/L-3225P12		32	25	170	42	22	SMS-432	LCS-617	CP50-22	CS7-6030	LW030
MSBNR/L-3232P12		32	32	170	42	27	SMS-432	LCS-617	CP50-22	CS7-6030	LW030
MSBNR/L-2020K15	SNMG1506	20	20	125	40	17	SMS-533	LCS-0822	CP50-22	CS7-6030	LW030
MSBNR/L-2525M15		25	25	150	40	22	SMS-533	LCS-0822	CP50-22	CS7-6030	LW030
MSBNR/L-3225P15		32	25	170	42	22	SMS-533	LCS-0822	CP50-22	CS7-6030	LW030
MSBNR/L-3232P15		32	32	170	42	27	SMS-533	LCS-0822	CP50-22	CS7-6030	LW030
MSBNR/L-2525M19	SNMG1906	25	25	150	42	22	SMS-633	LCS-1022	CP50-29	CS7-8030	LW040
MSBNR/L-3225P19		32	25	170	42	22	SMS-633	LCS-1022	CP50-29	CS7-8030	LW040
MSBNR/L-3232P19		32	32	170	42	27	SMS-633	LCS-1022	CP50-29	CS7-8030	LW040
MSBNR/L-4040S19		40	40	250	42	35	SMS-633	LCS-1022	CP50-29	CS7-8030	LW040

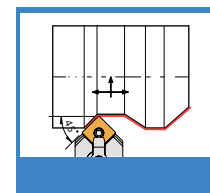
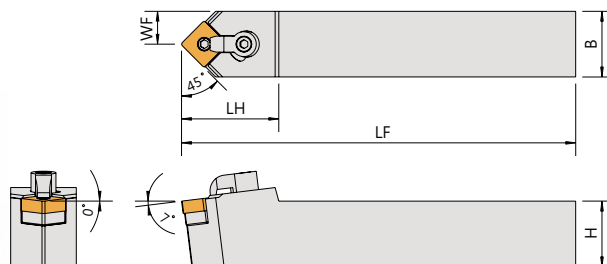
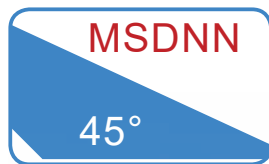

Order No.	Insert	Dimensions(mm)					Parts				Wrench
		柄高 H	柄寬 B	長度 LF	頭長 LH	工作寬度 WF					
MSDNN-2020K12	SNMG1204	20	20	125	35	10	SMS-432	LCS-617	CP50-22	CS7-6030	LW030
MSDNN-2525M12		25	25	150	37	12.5	SMS-432	LCS-617	CP50-22	CS7-6030	LW030
MSDNN-3225P12		32	25	170	42	12.5	SMS-432	LCS-617	CP50-22	CS7-6030	LW030
MSDNN-3232P12		32	32	170	43	16	SMS-432	LCS-617	CP50-22	CS7-6030	LW030

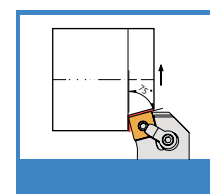
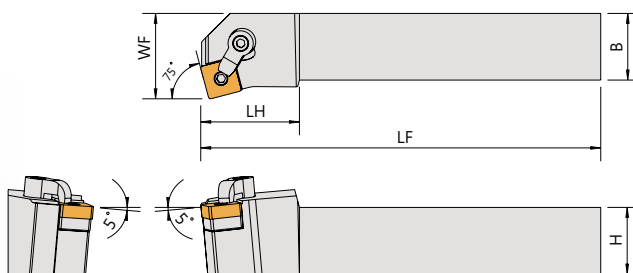
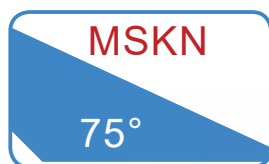

Order No.	Insert	Dimensions(mm)					Parts				Wrench
		柄高 H	柄寬 B	長度 LF	頭長 LH	工作寬度 WF					
MSKNR/L-2020K12	SNMG1204	20	20	125	37	25	SMS-432	LCS-617	CP50-22	CS7-6030	LW030
MSKNR/L-2525M12		25	25	150	37	32	SMS-432	LCS-617	CP50-22	CS7-6030	LW030
MSKNR/L-3225P12		32	25	170	42	32	SMS-432	LCS-617	CP50-22	CS7-6030	LW030
MSKNR/L-3232P12		32	32	170	42	40	SMS-432	LCS-617	CP50-22	CS7-6030	LW030
MSKNR/L-2525M15	SNMG1506	25	25	150	37	32	SMS-432	LCS-0822	CP50-22	CS7-6030	LW030
MSKNR/L-3225P15		32	25	170	42	32	SMS-533	LCS-0822	CP50-22	CS7-6030	LW030
MSKNR/L-3232P15		32	32	170	42	40	SMS-533	LCS-0822	CP50-22	CS7-6030	LW030
MSKNR/L-4040S19	SNMG1906	40	40	250	42	50	SMS-633	LCS-1022	CP50-29	CS7-8030	LW040

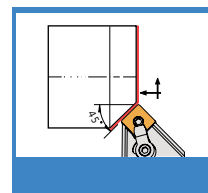
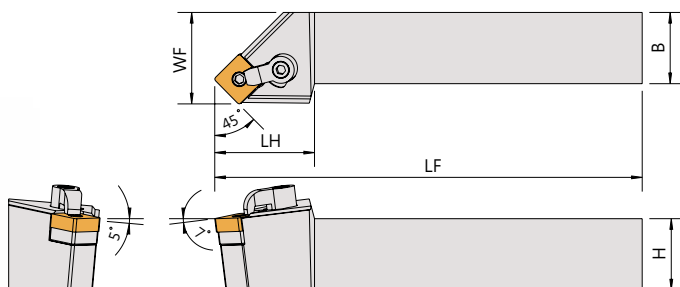

Order No.	Insert	Dimensions(mm)					Parts				Wrench	
		柄高 H	柄寬 B	長度 LF	頭長 LH	工作寬度 WF						
MSSNR/L-2020K12	SNMG1204	20	20	125	33	25	SMS-432	LCS-617	CP50-22	CS7-6030	LW030	
MSSNR/L-2525M12		25	25	150	33	32	SMS-432	LCS-617	CP50-22	CS7-6030	LW030	
MSSNR/L-3225P12		32	25	170	36	32	SMS-432	LCS-617	CP50-22	CS7-6030	LW030	
MSSNR/L-3232P12		32	32	170	40	40	SMS-432	LCS-617	CP50-22	CS7-6030	LW030	
MSSNR/L-2525M15	SNMG1506	25	25	150	40	32	SMS-533	LCS-0822	CP50-22	CS7-6030	LW030	
MSSNR/L-3225P15		32	25	170	40	40	SMS-533	LCS-0822	CP50-22	CS7-6030	LW030	
MSSNR/L-3232P15		32	32	170	40	40	SMS-533	LCS-0822	CP50-22	CS7-6030	LW030	
MSSNR/L-3232P19	SNMG1906	32	32	170	42	40	SMS-633	LCS-1022	CP50-29	CS7-8030	LW040	
MSSNR/L-4040S19		40	40	250	42	50	SMS-633	LCS-1022	CP50-29	CS7-8030	LW040	

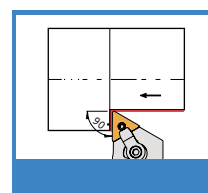
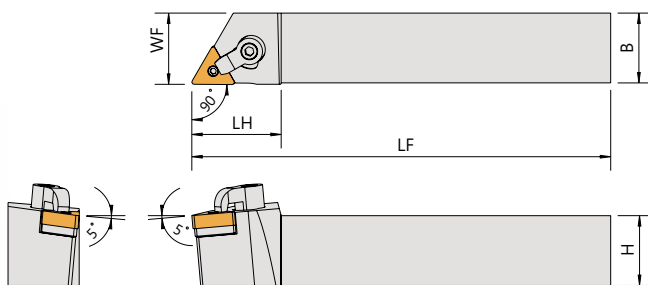
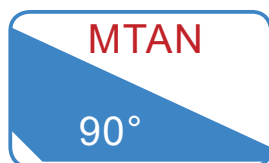

Order No.	Insert	Dimensions(mm)					Parts				Wrench	
		柄高 H	柄寬 B	長度 LF	頭長 LH	工作寬度 WF						
MTANR/L-2020K16	TNMG1604	20	20	125	32	20.5	SMT-322	LCS-513	CP50-22	CS7-6030	LW020	LW030
MTANR/L-2525M16		25	25	150	32	25.5	SMT-322	LCS-513	CP50-22	CS7-6030	LW020	LW030

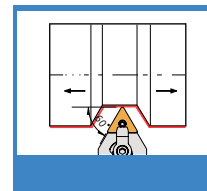
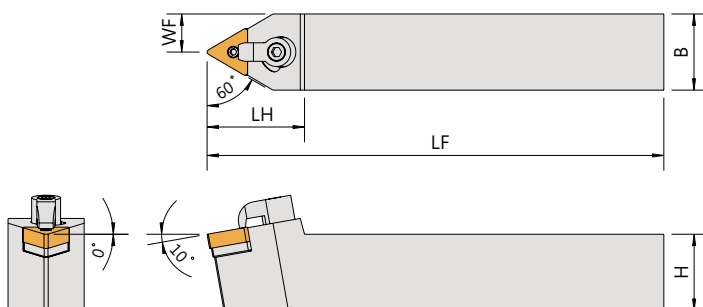
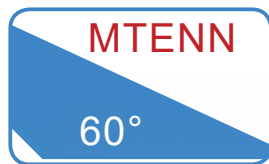

Order No.	Insert	Dimensions(mm)					Parts				Wrench	
		柄高 H	柄寬 B	長度 LF	頭長 LH	工作寬度 WF						
MTENN-2020K16	TNMG1604	20	20	125	38	10					LW020	LW030
MTENN-2525M16		25	25	150	40	12.5					LW020	LW030
MTENN-3225P16		32	25	170	38	12.5					LW020	LW030
MTENN-3232P16		32	32	170	43	16					LW020	LW030
MTENN-2525M22	TNMG2204	25	25	150	40	12.5					LW030	LW040
MTENN-3225P22		32	25	170	43	12.5					LW030	LW040
MTENN-3232P22		32	32	170	43	16					LW030	LW040

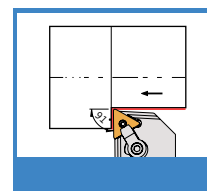
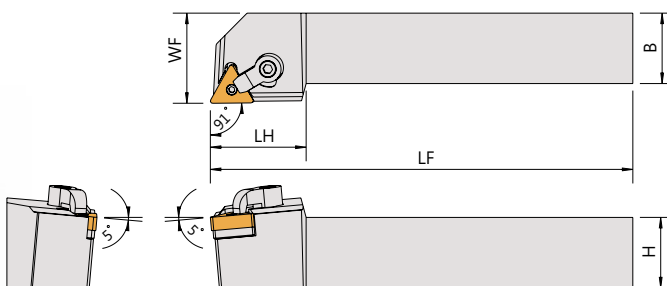
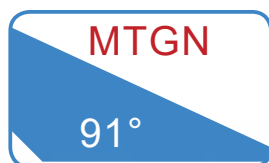

Order No.	Insert	Dimensions(mm)					Parts				Wrench	
		柄高 H	柄寬 B	長度 LF	頭長 LH	工作寬度 WF						
MTGNR/L-1616H16	TNMG1604	16	16	100	30	20					LW020	LW030
MTGNR/L-2020K16		20	20	125	34	25					LW020	LW030
MTGNR/L-2525M16		25	25	150	34	32					LW020	LW030
MTGNR/L-3232P16		32	32	170	34	40					LW020	LW030

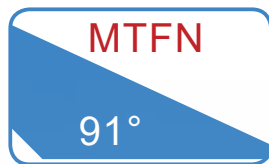

MTFN

91°

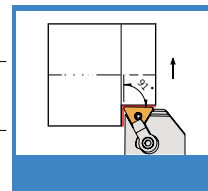
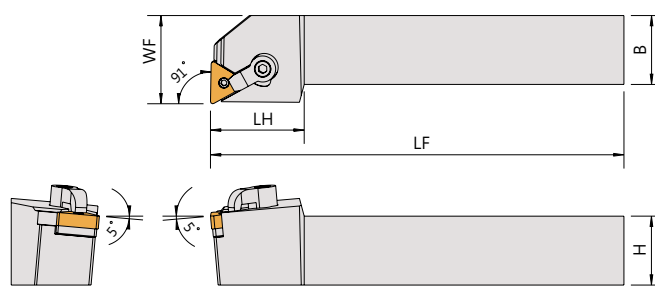

Order No.	Insert	Dimensions(mm)					Parts				Wrench		
		柄高 H	柄寬 B	長度 LF	頭長 LH	工作寬度 WF							
MTFNR/L-1616H16	TNMG1604	16	16	100	30	20						LW020	LW030
MTFNR/L-2020K16		20	20	125	34	25						LW020	LW030
MTFNR/L-2525M16		25	25	150	34	32						LW020	LW030

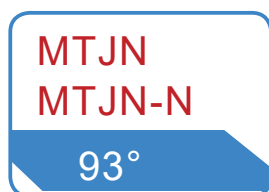

MTJN  
MTJN-N

93°

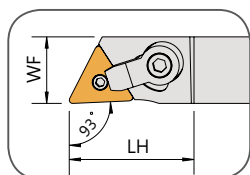

MTJN-N

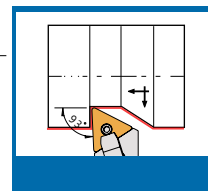
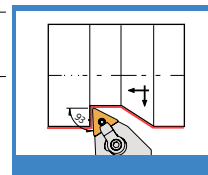
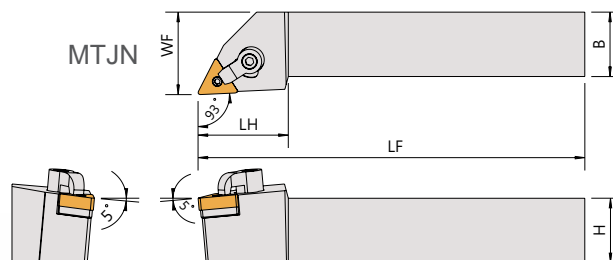

Order No.	Insert	Dimensions(mm)					Parts				Wrench		
		柄高 H	柄寬 B	長度 LF	頭長 LH	工作寬度 WF							
MTJNR/L-1616H16	TNMG1604	16	16	100	30	20						LW020	LW030
MTJNR/L-2020K16		20	20	125	33	25						LW020	LW030
MTJNR/L-2525M16		25	25	150	35	32						LW020	LW030
MTJNR/L-3225P16		32	25	170	43	32						LW020	LW030
MTJNR/L-3232P16		32	32	170	43	40						LW020	LW030
MTJNR/L-2525M22	TNMG2204	25	25	150	43	32						LW030	LW040
MTJNR/L-3225P22		32	25	170	43	32						LW030	LW040
MTJNR/L-3232P22		32	32	170	43	40						LW030	LW040
MTJNR/L-4040S22		40	40	250	43	50						LW030	LW040
MTJNR/L-4040S27	TNMG2706	40	40	250	43	50						LW030	LW040
MTJNR/L-1212H16N	TNMG1604	12	12	100	30	12	-				LW020	LW030	
MTJNR/L-1616H16N		16	16	100	30	16					LW020	LW030	

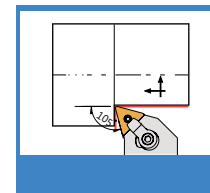
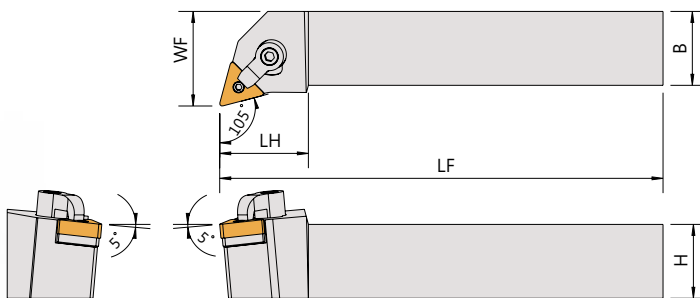
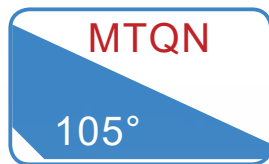

Order No.	Insert	Dimensions(mm)					Parts				Wrench	
		柄高 H	柄寬 B	長度 LF	頭長 LH	工作寬度 WF						
MTQNR/L-2020K16	TNMG1604	20	20	125	30	25	SMT-322	LCS-513	CP50-22	CS7-6030	LW020	LW030
MTQNR/L-2525M16		25	25	150	30	32	SMT-322	LCS-513	CP50-22	CS7-6030	LW020	LW030

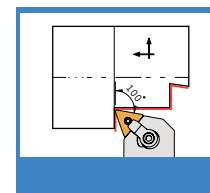
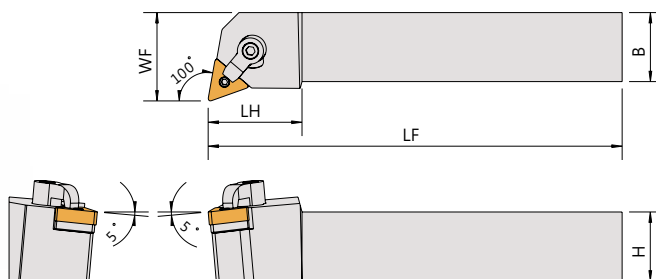
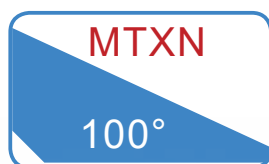

Order No.	Insert	Dimensions(mm)					Parts				Wrench	
		柄高 H	柄寬 B	長度 LF	頭長 LH	工作寬度 WF						
MTXNR/L-2020K16	TNMG1604	20	20	125	34	25	SMT-322	LCS-513	CP50-22	CS7-6030	LW020	LW030
MTXNR/L-2525M16		25	25	150	34	32	SMT-322	LCS-513	CP50-22	CS7-6030	LW020	LW030

**MVVNN**  
**MVVN**  
72.5°

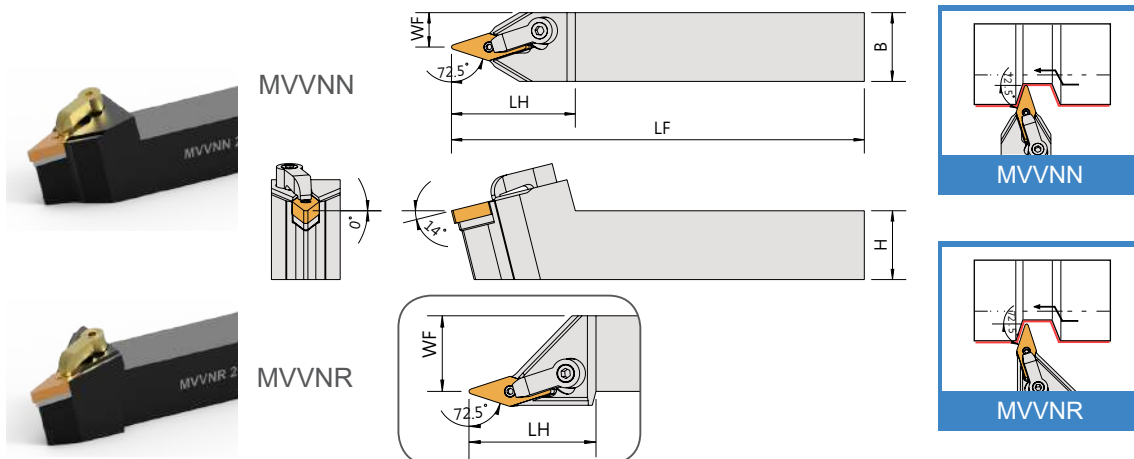

Order No.	Insert	Dimensions(mm)					Parts				Wrench	
		柄高 H	柄寬 B	長度 LF	頭長 LH	工作寬度 WF						
MVVNN-2020K16	VNMG1604	20	20	125	45	10	SMV-322	LCS-513	CP50-25	CS7-6030	LW020	LW030
MVVNN-2525M16		25	25	150	45	12.5	SMV-322	LCS-513	CP50-25	CS7-6030	LW020	LW030
MVVNN-3225P16		32	25	170	45	12.5	SMV-322	LCS-513	CP50-25	CS7-6030	LW020	LW030
MVVNN-3232P16		32	32	170	45	16	SMV-322	LCS-513	CP50-25	CS7-6030	LW020	LW030
MVVNR/L-2020K16		20	20	125	42	20	SMV-322	LCS-513	CP50-25	CS7-6030	LW020	LW030
MVVNR/L-2525M16		25	25	150	42	25	SMV-322	LCS-513	CP50-25	CS7-6030	LW020	LW030

**MWLN**  
95°

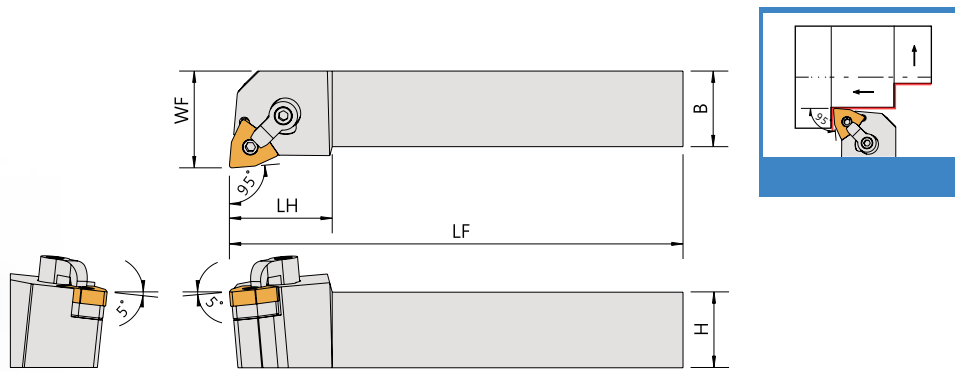

Order No.	Insert	Dimensions(mm)					Parts				Wrench	
		柄高 H	柄寬 B	長度 LF	頭長 LH	工作寬度 WF						
MWLN/L-2020K06	WNMG0604	20	20	125	26	25	SMW-321	LCS-513	CP50-30	CS7-5018	LW020	LW025
MWLN/L-2525M06		25	25	150	26	32	SMW-321	LCS-513	CP50-30	CS7-5018	LW020	LW025
MWLN/L-2020K08	WNMG0804	20	20	125	26	25	SMW-432	LCS-617	CP50-22	CS7-6030	-	LW030
MWLN/L-2525M08		25	25	150	26	32	SMW-432	LCS-617	CP50-22	CS7-6030	-	LW030
MWLN/L-3225P08		32	25	170	26	32	SMW-432	LCS-617	CP50-22	CS7-6030	-	LW030
MWLN/L-3232P08		32	32	170	26	40	SMW-432	LCS-617	CP50-22	CS7-6030	-	LW030



**MVJN**  
**MVJN-M**

93°



→ MVJNR-2525M16M

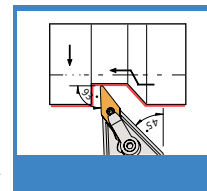
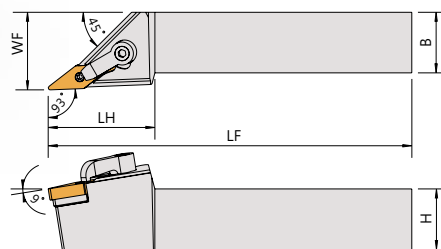

Order No.	Insert	Dimensions(mm)					Parts				Wrench	
		柄高 H	柄寬 B	長度 LF	頭長 LH	工作寬度 WF						
MVJNR/L-2020K16	VNMG1604	20	20	125	39	25	SMV-322	LCS-513	CP50-25	CS7-6030	LW020	LW030
MVJNR/L-2525M16		25	25	150	44	32	SMV-322	LCS-513	CP50-25	CS7-6030	LW020	LW030
MVJNR/L-3225P16		32	25	170	44	32	SMV-322	LCS-513	CP50-25	CS7-6030	LW020	LW030
MVJNR/L-3232P16		32	32	170	45	40	SMV-322	LCS-513	CP50-25	CS7-6030	LW020	LW030
MVJNR/L-2020K16M	VNMG1604	20	20	125	43	25	SMV-322	LCS-513	CP50-25	CS7-6030	LW020	LW030
MVJNR/L-2525M16M		25	25	150	43	32	SMV-322	LCS-513	CP50-25	CS7-6030	LW020	LW030

**MVQN**

107.5°  
117.5°

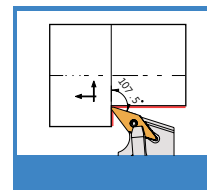
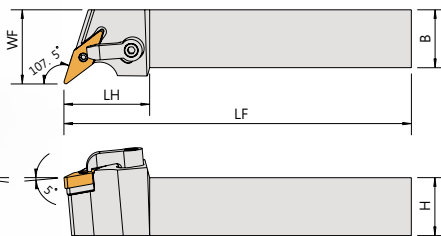
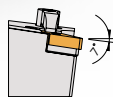

Order No.	Insert	Dimensions(mm)					Parts				Wrench	
		柄高 H	柄寬 B	長度 LF	頭長 LH	工作寬度 WF						
MVQNR/L-2020K16	VNMG1604	20	20	125	36	25	SMV-322	LCS-513	CP50-25	CS7-6030	LW020	LW030
MVQNR/L-2020K16-117.5		20	20	125	38	25						
MVQNR/L-2525M16		25	25	150	36	32						
MVQNR/L-2525M16-117.5		25	25	150	38	32						
MVQNR/L-3225P16		32	25	170	36	32						
MVQNR/L-3225P16-117.5		32	25	170	42	32						
MVQNR/L-3232P16		32	32	170	36	40						
MVQNR/L-3232P16-117.5		32	32	170	42	40						

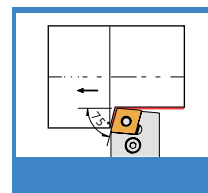
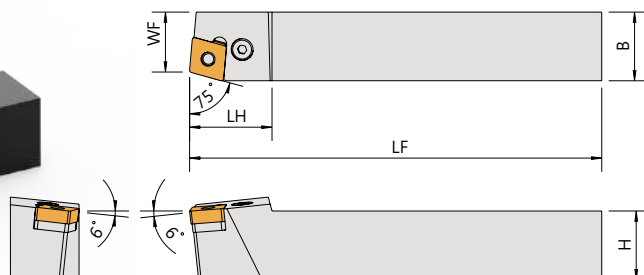
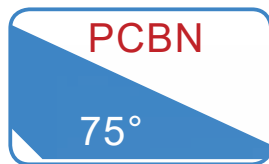

Order No.	Insert	Dimensions(mm)					Parts				Wrench
		柄高 H	柄寬 B	長度 LF	頭長 LH	工作寬度 WF					
PCBNR/L-2020K12	CNMG1204	20	20	125	30	17	SMC-422	CS-LSP4	CP-LL4	CS-LS4	LW030
PCBNR/L-2525M12		25	25	150	30	22	SMC-422	CS-LSP4	CP-LL4	CS-LS4	LW030
PCBNR/L-3225P12		32	25	170	30	22	SMC-422	CS-LSP4	CP-LL4	CS-LS4	LW030
PCBNR/L-3232P12		32	32	170	30	29	SMC-422	CS-LSP4	CP-LL4	CS-LS4	LW030

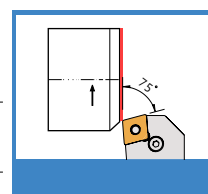
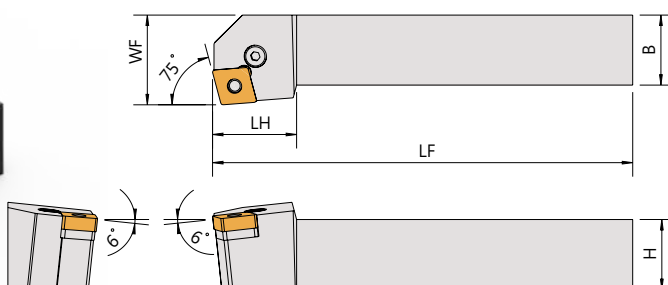
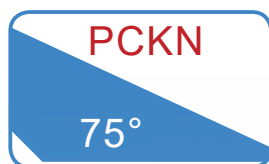

Order No.	Insert	Dimensions(mm)					Parts				Wrench
		柄高 H	柄寬 B	長度 LF	頭長 LH	工作寬度 WF					
PCKNR/L-2020K12	CNMG1204	20	20	125	26	25	SMC-422	CS-LSP4	CP-LL4	CS-LS4	LW030
PCKNR/L-2525M12		25	25	150	26	32	SMC-422	CS-LSP4	CP-LL4	CS-LS4	LW030
PCKNR/L-3225P12		32	25	170	26	32	SMC-422	CS-LSP4	CP-LL4	CS-LS4	LW030
PCKNR/L-3232P12		32	32	170	40	40	SMC-422	CS-LSP4	CP-LL4	CS-LS4	LW030

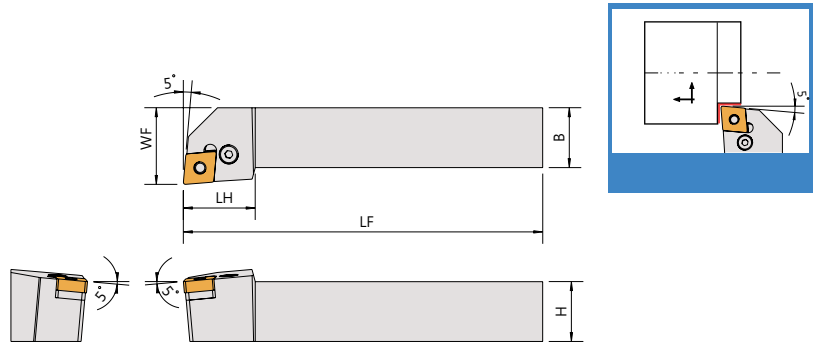
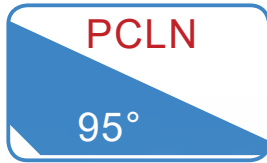

Order No.	Insert	Dimensions(mm)					Parts				Wrench
		柄高 H	柄寬 B	長度 LF	頭長 LH	工作寬度 WF					
PCLNR/L-1616H09	CNMG0903	16	16	100	20	20	SMC-322	CS-LSP3	CP-LL3	CS-LS3	LW025
PCLNR/L-2020K12	CNMG1204	20	20	125	26	25	SMC-422	CS-LSP4	CP-LL4	CS-LS4	LW030
PCLNR/L-2525M12		25	25	150	26	32	SMC-422	CS-LSP4	CP-LL4	CS-LS4	LW030
PCLNR/L-3225P12		32	25	170	26	32	SMC-422	CS-LSP4	CP-LL4	CS-LS4	LW030
PCLNR/L-3232P12		32	32	170	33	40	SMC-422	CS-LSP4	CP-LL4	CS-LS4	LW030
PCLNR/L-2525M16	CNMG1606	25	25	150	33	32	SMC-532	CS-LSP7	CP-LL7	CS-LS7	LW030
PCLNR/L-2525M19	CNMG1906	25	25	150	36	32	SMC-632	CS-LSP8	CP-LL8	CS-LS8	LW040

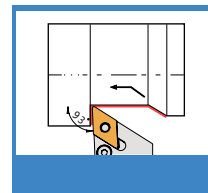
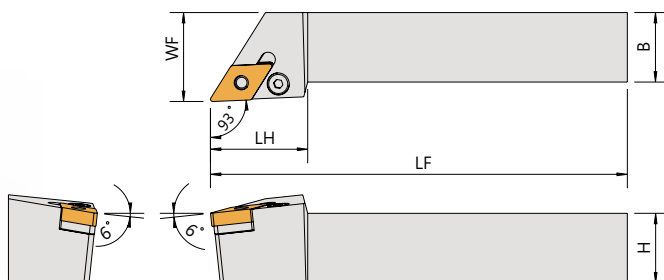
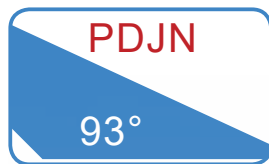

Order No.	Insert	Dimensions(mm)					Parts					Wrench
		柄高 H	柄寬 B	長度 LF	頭長 LH	工作寬度 WF						
PDJNR/L-2020K11	DNMG1104	20	20	125	35	25	SMD-331	CS-LSP3	CP-LL6	CS-LS3	LW025	
PDJNR/L-2525M11		25	25	150	35	32	SMD-331	CS-LSP3	CP-LL6	CS-LS3	LW025	
PDJNR/L-2020K1504	DNMG1504	25	25	150	36	25	SMD-424	CS-LSP4	CP-LL4	CS-LS4	LW030	
PDJNR/L-2525M1504		25	25	150	36	32	SMD-424	CS-LSP4	CP-LL4	CS-LS4	LW030	
PDJNR/L-3225P1504		32	25	170	38	32	SMD-424	CS-LSP4	CP-LL4	CS-LS4	LW030	
PDJNR/L-3232P1504		32	32	170	38	40	SMD-424	CS-LSP4	CP-LL4	CS-LS4	LW030	
PDJNR/L-2020K1506	DNMG1506	25	25	150	36	25	SMD-424	CS-LSP4	CP-LL4	CS-LS7	LW030	
PDJNR/L-2525M1506		25	25	150	36	32	SMD-424	CS-LSP4	CP-LL4	CS-LS7	LW030	
PDJNR/L-3225P1506		32	25	170	38	32	SMD-424	CS-LSP4	CP-LL4	CS-LS7	LW030	
PDJNR/L-3232P1506		32	32	170	38	40	SMD-424	CS-LSP4	CP-LL4	CS-LS7	LW030	

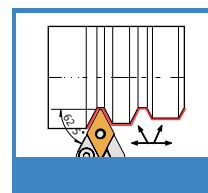
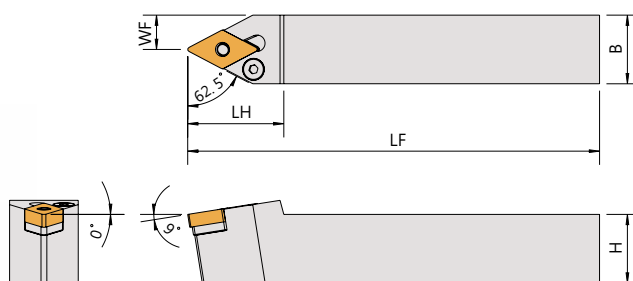
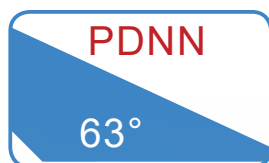

Order No.	Insert	Dimensions(mm)					Parts					Wrench
		柄高 H	柄寬 B	長度 LF	頭長 LH	工作寬度 WF						
PDNNR-2525M1504	DNMG1504	25	25	150	35	12.5	SMD-424	CS-LSP4	CP-LL4	CS-LS4	LW030	
PDNNR-3225P1504		32	25	170	35	12.5	SMD-424	CS-LSP4	CP-LL4	CS-LS4	LW030	
PDNNR-3232P1504		32	32	170	35	16	SMD-424	CS-LSP4	CP-LL4	CS-LS4	LW030	
PDNNR-2525M1506	DNMG1506	25	25	150	35	12.5	SMD-424	CS-LSP4	CP-LL4	CS-LS7	LW030	
PDNNR-3225P1506		32	25	170	35	12.5	SMD-424	CS-LSP4	CP-LL4	CS-LS7	LW030	
PDNNR-3232P1506		32	32	170	35	16	SMD-424	CS-LSP4	CP-LL4	CS-LS7	LW030	

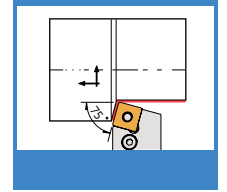
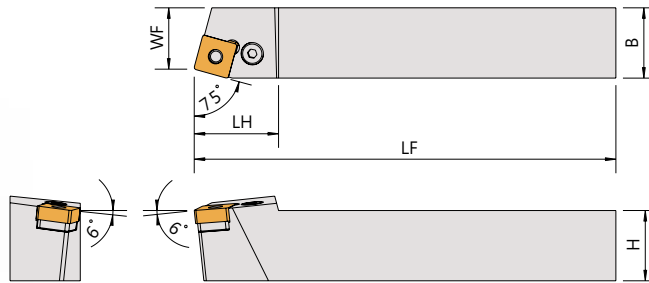

Order No.	Insert	Dimensions(mm)					Parts				Wrench
Right / Left		柄高	柄寬	長度	頭長	工作寬度					
		H	B	LF	LH	WF					
PSBNR/L-2020K12	SNMG1204	20	20	125	30	17	SMS-422	CS-LSP4	CP-LL4	CS-LS4	LW030
PSBNR/L-2525M12		25	25	150	30	22	SMS-422	CS-LSP4	CP-LL4	CS-LS4	LW030
PSBNR/L-3225P12		32	25	170	30	22	SMS-422	CS-LSP4	CP-LL4	CS-LS4	LW030
PSBNR/L-3232P12		32	32	170	35	29	SMS-422	CS-LSP4	CP-LL4	CS-LS4	LW030

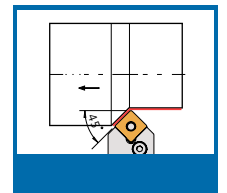
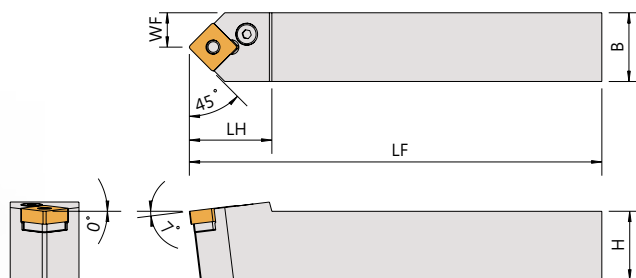

Order No.	Insert	Dimensions(mm)					Parts				Wrench
Right / Left		柄高	柄寬	長度	頭長	工作寬度					
		H	B	LF	LH	WF					
PSDNN-2020K12	SNMG1204	20	20	125	30	17	SMS-422	CS-LSP4	CP-LL4	CS-LS4	LW030
PSDNN-2525M12		25	25	150	30	12.5	SMS-422	CS-LSP4	CP-LL4	CS-LS4	LW030
PSDNN-3225P12		32	25	170	30	12.5	SMS-422	CS-LSP4	CP-LL4	CS-LS4	LW030
PSDNN-3232P12		32	32	170	30	16	SMS-422	CS-LSP4	CP-LL4	CS-LS4	LW030

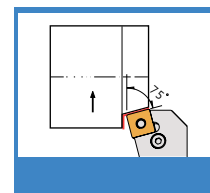
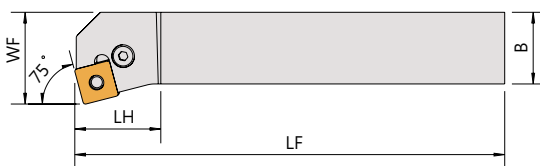

Order No.	Insert	Dimensions(mm)					Parts				Wrench
		柄高 H	柄寬 B	長度 LF	頭長 LH	工作寬度 WF					
PSKNR/L-2020K12	SNMG1204	20	20	125	30	25	SMS-422	CS-LSP4	CP-LL4	CS-LS4	LW030
PSKNR/L-2525M12		25	25	150	30	32	SMS-422	CS-LSP4	CP-LL4	CS-LS4	LW030
PSKNR/L-3225P12		32	25	170	30	32	SMS-422	CS-LSP4	CP-LL4	CS-LS4	LW030
PSKNR/L-3232P12		32	32	170	30	40	SMS-422	CS-LSP4	CP-LL4	CS-LS4	LW030
PSKNR/L-3225M15	SNMG1506	32	25	150	30	32	SMS-532	CS-LSP7	CP-LL7	CS-LS7	LW030

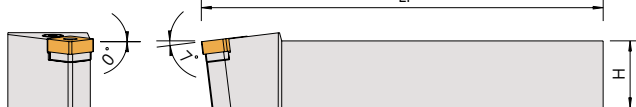
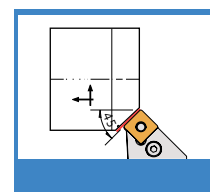
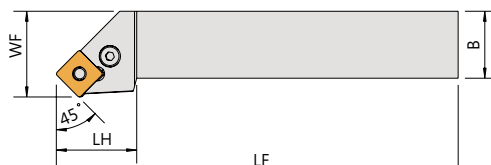

Order No.	Insert	Dimensions(mm)					Parts				Wrench
		柄高 H	柄寬 B	長度 LF	頭長 LH	工作寬度 WF					
PSSNR/L-2020K12	SNMG1204	20	20	125	30	25	SMS-422	CS-LSP4	CP-LL4	CS-LS4	LW030
PSSNR/L-2525M12		25	25	150	30	32	SMS-422	CS-LSP4	CP-LL4	CS-LS4	LW030
PSSNR/L-3225P12		32	25	170	30	32	SMS-422	CS-LSP4	CP-LL4	CS-LS4	LW030
PSSNR/L-3232P12		32	32	170	36	40	SMS-422	CS-LSP4	CP-LL4	CS-LS4	LW030

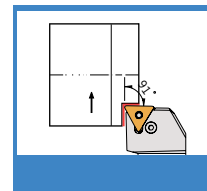
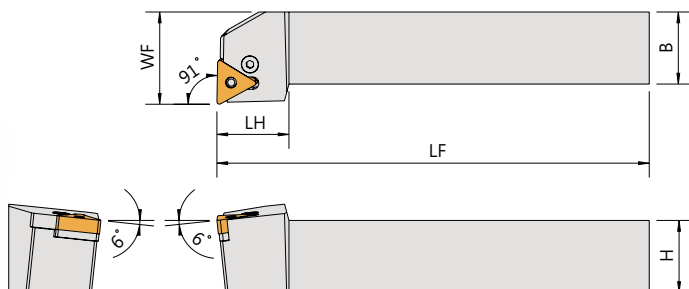
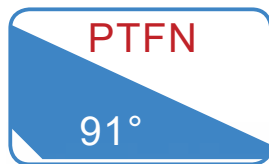

Order No.	Insert	Dimensions(mm)					Parts				Wrench
		柄高	柄寬	長度	頭長	工作寬度					
Right / Left		H	B	LF	LH	WF					
PTFNR/L-2020K16	TNMG1604	20	20	125	20	25	SMT-31T	CS-LSP3	CP-LL3	CS-LS3	LW025
PTFNR/L-2525M16		25	25	150	20	32	SMT-31T	CS-LSP3	CP-LL3	CS-LS3	LW025

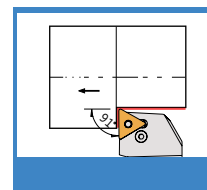
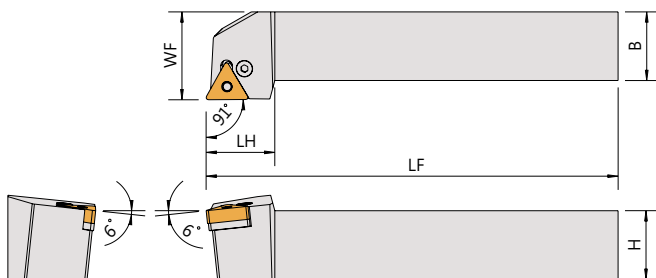
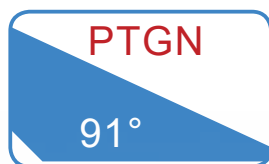

Order No.	Insert	Dimensions(mm)					Parts				Wrench
		柄高	柄寬	長度	頭長	工作寬度					
Right / Left		H	B	LF	LH	WF					
PTGNR/L-2020K16	TNMG1604	20	20	125	20	25	SMT-31T	CS-LSP3	CP-LL3	CS-LS3	LW025
PTGNR/L-2525M16		25	25	150	20	32	SMT-31T	CS-LSP3	CP-LL3	CS-LS3	LW025



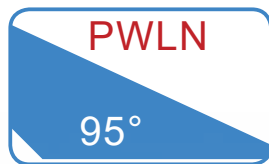

PWLN

95°

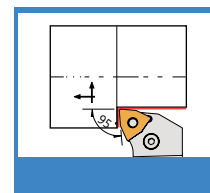
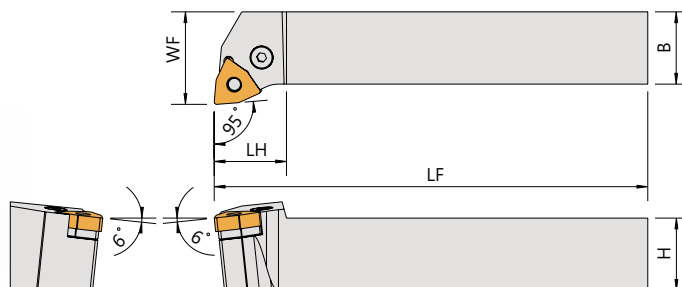

Order No.	Insert	Dimensions(mm)					Parts				Wrench
		柄高 H	柄寬 B	長度 LF	頭長 LH	工作寬度 WF					
PWLN/L-1616H06	WNMG0604	16	16	100	20	20	SMW-322	CS-LSP3	CP-LL3	CS-LS3	LW025
PWLN/L-2020K06		20	20	125	20	25	SMW-322	CS-LSP3	CP-LL3	CS-LS3	LW025
PWLN/L-2525M06		25	25	150	23	32	SMW-322	CS-LSP3	CP-LL3	CS-LS3	LW025
PWLN/L-2020K08	WNMG0804	20	20	125	20	25	SMW-423	CS-LSP4	CP-LL4	CS-LS4	LW030
PWLN/L-2525M08		25	25	150	26	32	SMW-423	CS-LSP4	CP-LL4	CS-LS4	LW030
PWLN/L-3225P08		32	25	170	26	32	SMW-423	CS-LSP4	CP-LL4	CS-LS4	LW030
PWLN/L-3232P08		32	32	170	30	40	SMW-423	CS-LSP4	CP-LL4	CS-LS4	LW030

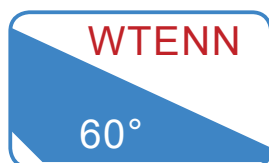

WTENN

60°

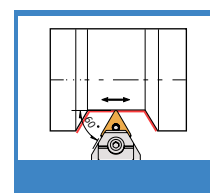
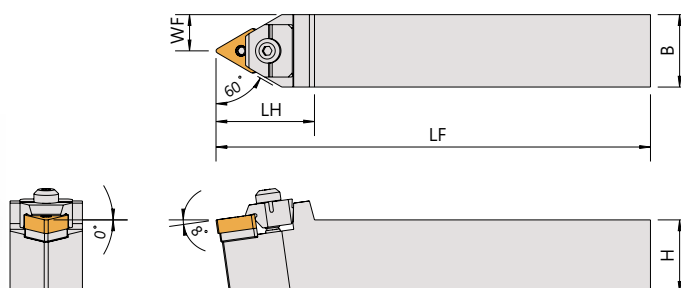

Order No.	Insert	Dimensions(mm)					Parts					Wrench	
		柄高 H	柄寬 B	長度 LF	頭長 LH	工作寬度 WF							
WTENN-2020K16	TNMG1604	20	20	125	34	10	SMT-322	LCS-420N	MWW-30	CSE5026	ER04	LW025	LW030
WTENN-2525M16		25	25	150	34	12.5	SMT-322	LCS-420N	MWW-30	CSE5026	ER04	LW025	LW030
WTENN-3225P16		32	25	170	34	12.5	SMT-322	LCS-420N	MWW-30	CSE5026	ER04	LW025	LW030
WTENN-3232P16		32	32	170	34	16	SMT-322	LCS-420N	MWW-30	CSE5026	ER04	LW025	LW030

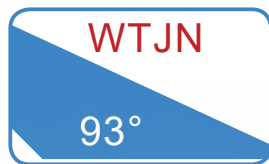

WTJN

93°

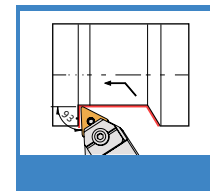
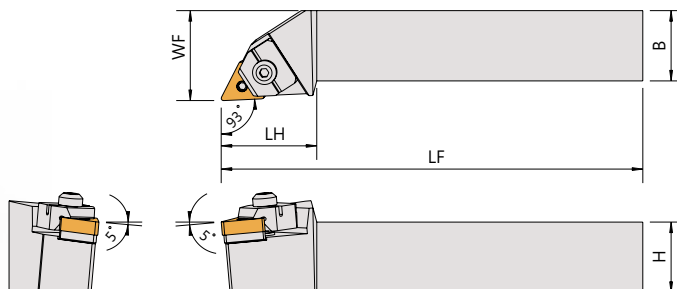

Order No.	Insert	Dimensions(mm)					Parts					Wrench	
		柄高 H	柄寬 B	長度 LF	頭長 LH	工作寬度 WF							
WTJNR/L-2020K16	TNMG1604	20	20	125	34	25						LW025	LW030
WTJNR/L-2525M16		25	25	150	34	32						LW025	LW030
WTJNR/L-3225P16		32	25	170	34	32						LW025	LW030
WTJNR/L-3232P16		32	32	170	34	40						LW025	LW030



WTXN

100°

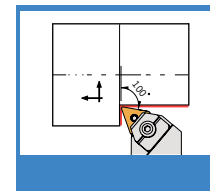
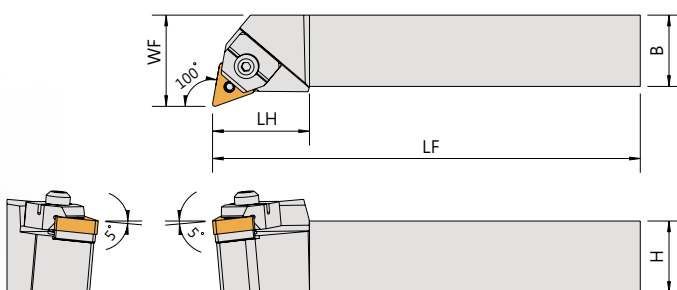

Order No.	Insert	Dimensions(mm)					Parts					Wrench	
		柄高 H	柄寬 B	長度 LF	頭長 LH	工作寬度 WF							
WTXNR/L-2020K16	TNMG1604	20	20	125	33	25						LW025	LW030
WTXNR/L-2525M16		25	25	150	34	32						LW025	LW030

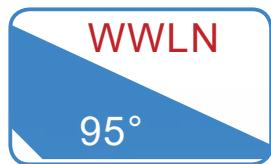

WWLN

95°

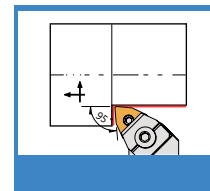
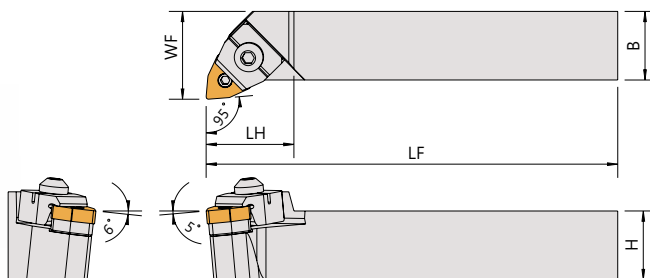

Order No.	Insert	Dimensions(mm)					Parts					Wrench	
Right / Left		柄高	柄寬	長度	頭長	工作寬度							
		H	B	LF	LH	WF							
WWLNR/L-2020K08	WNMG0804	20	20	125	32	25	SMW-433	LCS-520N	MMW-40	CSE6030	ER05	LW025	LW040
WWLNR/L-2525M08		25	25	150	32	32	SMW-433	LCS-520N	MMW-40	CSE6030	ER05	LW025	LW040
WWLNR/L-3225P08		32	25	170	32	32	SMW-433	LCS-520N	MMW-40	CSE6030	ER05	LW025	LW040
WWLNR/L-3232P08		32	32	170	32	40	SMW-433	LCS-520N	MMW-40	CSE6030	ER05	LW025	LW040

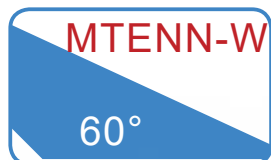

MTENN-W

60°

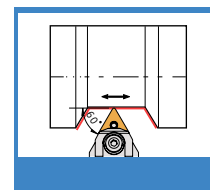
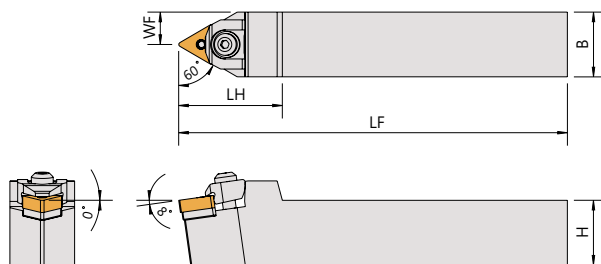

Order No.	Insert	Dimensions(mm)					Parts					Wrench		
Right / Left		柄高	柄寬	長度	頭長	工作寬度								
		H	B	LF	LH	WF								
MTENN-2020K16W	TNMG1604	20	20	125	32	10	SMT-322	LCS-420N	MTW-30	CSE5026	ER04	WS06	LW025	LW030
MTENN-2525M16W		25	25	150	32	12.5	SMT-322	LCS-420N	MTW-30	CSE5026	ER04	WS06	LW025	LW030
MTENN-3225P16W		32	25	170	32	12.5	SMT-322	LCS-420N	MTW-30	CSE5026	ER04	WS06	LW025	LW030
MTENN-3232P16W		32	32	170	32	16	SMT-322	LCS-420N	MTW-30	CSE5026	ER04	WS06	LW025	LW030
MTENN-2525M22W	TNMG2204	25	25	150	32	12.5	SMT-431	LCS-520W	MTW-34	CSE6027	ER25	WS06	LW025	LW040
MTENN-3225P22W		32	25	170	32	12.5	SMT-431	LCS-520W	MTW-34	CSE6027	ER25	WS06	LW025	LW040
MTENN-3232P22W		32	32	170	32	16	SMT-431	LCS-520W	MTW-34	CSE6027	ER25	WS06	LW025	LW040

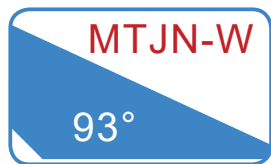

MTJN-W

93°

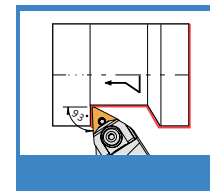
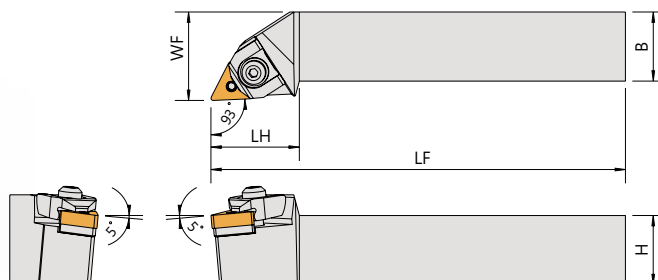

Order No.	Insert	Dimensions(mm)					Parts						Wrench	
		柄高	柄寬	長度	頭長	工作寬度								
Right / Left		H	B	LF	LH	WF								
MTJNR/L-2020K16W	TNMG1604	20	20	125	32	25	SMT-322	LCS-420N	MTW-30	CSE5026	ER04	WS06	LW025	LW030
MTJNR/L-2525M16W		25	25	150	32	32	SMT-322	LCS-420N	MTW-30	CSE5026	ER04	WS06	LW025	LW030
MTJNR/L-3225P16W		32	25	170	32	32	SMT-322	LCS-420N	MTW-30	CSE5026	ER04	WS06	LW025	LW030
MTJNR/L-3232P16W		32	32	170	32	40	SMT-322	LCS-420N	MTW-30	CSE5026	ER04	WS06	LW025	LW030
MTJNR/L-2020K22W	TNMG2204	20	20	125	32	27	SMT-431	LCS-520W	MTW-34	CSE6027	ER25	WS06	LW025	LW030
MTJNR/L-2525M22W		25	25	150	32	32	SMT-431	LCS-520W	MTW-34	CSE6027	ER25	WS06	LW025	LW030
MTJNR/L-3225P22W		32	25	170	32	32	SMT-431	LCS-520W	MTW-34	CSE6027	ER25	WS06	LW025	LW030
MTJNR/L-3232P22W		32	32	170	32	40	SMT-431	LCS-520W	MTW-34	CSE6027	ER25	WS06	LW025	LW030

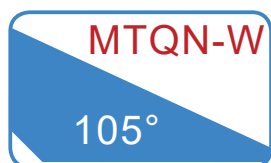

MTQN-W

105°

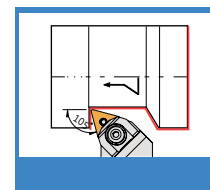
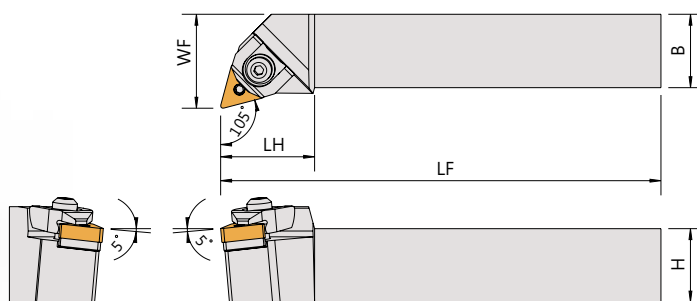

Order No.	Insert	Dimensions(mm)					Parts						Wrench	
		柄高	柄寬	長度	頭長	工作寬度								
Right / Left		H	B	LF	LH	WF								
MTQNR/L-2020K16W	TNMG1604	20	20	125	30	25	SMT-322	LCS-420N	MTW-30	CSE5026	ER04	WS06	LW025	LW030
MTQNR/L-2525M16W		25	25	150	30	32	SMT-322	LCS-420N	MTW-30	CSE5026	ER04	WS06	LW025	LW030
MTQNR/L-3232P16W		32	32	170	30	40	SMT-322	LCS-420N	MTW-30	CSE5026	ER04	WS06	LW025	LW030

**MTXN-W**  
100°

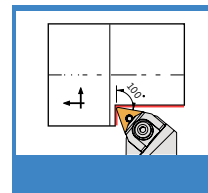
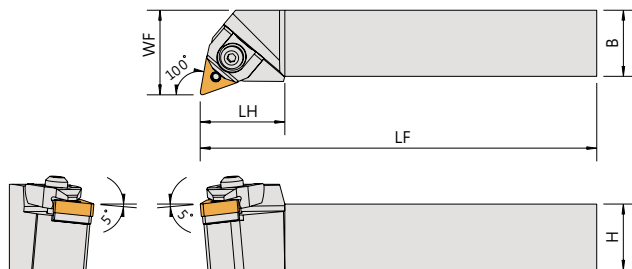

Order No.	Insert	Dimensions(mm)					Parts						Wrench	
		柄高 H	柄寬 B	長度 LF	頭長 LH	工作寬度 WF								
MTXNR/L-2020K16W	TNMG1604	20	20	125	32	25								
MTXNR/L-2525M16W		25	25	150	32	32								

**MWLN-W**  
95°

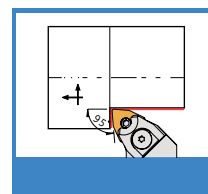
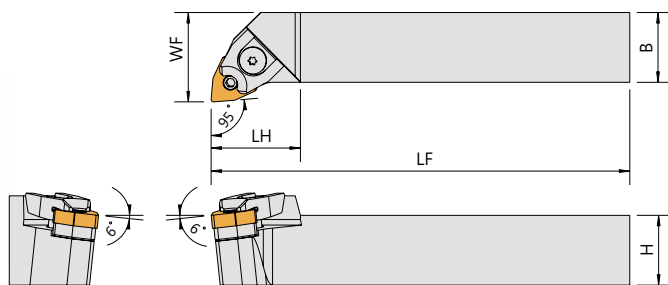

Order No.	Insert	Dimensions(mm)					Parts						Wrench	
		柄高 H	柄寬 B	長度 LF	頭長 LH	工作寬度 WF								
MWLN/L-2020K08W	WNMG0804	20	20	125	32	25								
MWLN/L-2525M08W		25	25	150	32	32								
MWLN/L-3225P08W		32	25	170	32	32								
MWLN/L-3232P08W		32	32	170	32	40								

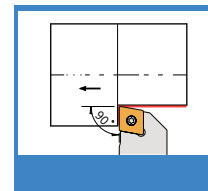
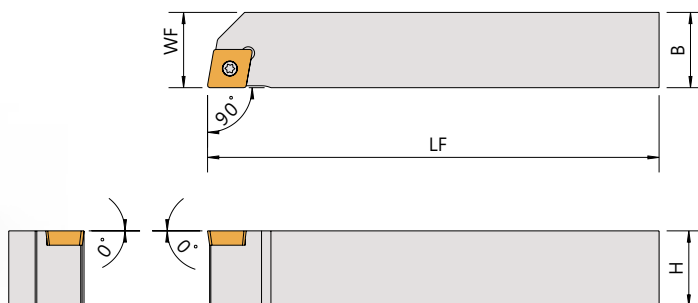
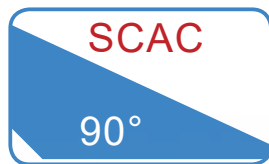

Order No.	Insert	Dimensions(mm)				Parts	Wrench
		柄高 H	柄寬 B	長度 LF	工作寬度 WF		
Right / Left							
SCACR/L-0808H06	CCMT0602	8	8	100	8	CS25061S	FT-7
SCACR/L-1010H06		10	10	100	10	CS25061S	FT-7
SCACR/L-1212H06		12	12	100	12	CS25061S	FT-7
SCACR/L-0808K06		8	8	125	8	CS25061S	FT-7
SCACR/L-1010K06		10	10	125	10	CS25061S	FT-7
SCACR/L-1212K06		12	12	125	12	CS25061S	FT-7
SCACR/L-1212H09	CCMT09T3	12	12	100	12	CS35090	FT-15
SCACR/L-1616H09		16	16	100	16	CS35090	FT-15
SCACR/L-1212K09		12	12	125	12	CS35090	FT-15
SCACR/L-1616K09		16	16	125	16	CS35090	FT-15
SCACR/L-2020K12	CCMT1204	20	20	125	20	CS40115	FT-15
SCACR/L-2525M12		25	25	150	25	CS40115	FT-15

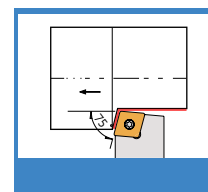
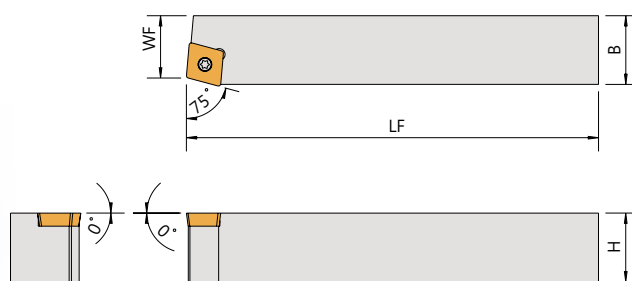
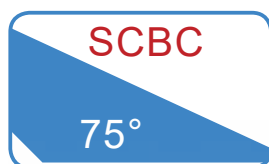

Order No.	Insert	Dimensions(mm)				Parts	Wrench
		柄高 H	柄寬 B	長度 LF	工作寬度 WF		
Right / Left							
SCBCR/L-2020K09	CCMT09T3	20	20	125	18.3	CS35090	FT-15
SCBCR/L-2525M09		25	25	150	23.3	CS35090	FT-15
SCBCR/L-2020K12	CCMT1204	20	20	125	17.5	CS40115	FT-15
SCBCR/L-2525M12		25	25	150	22.5	CS40115	FT-15

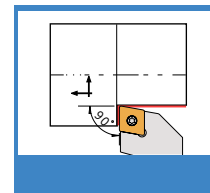
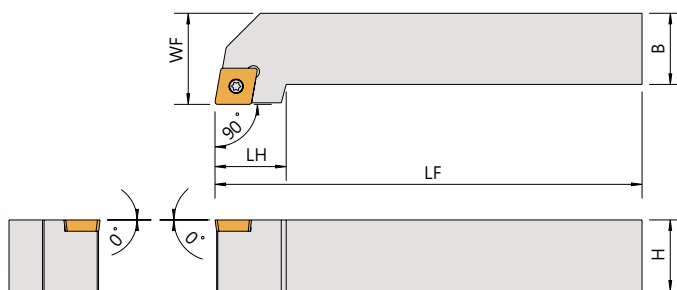
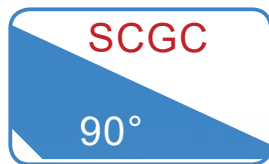

Order No.	Insert	Dimensions(mm)					Parts	Wrench
		柄高 H	柄寬 B	長度 LF	頭長 LH	工作寬度 WF		
SCGCR/L-0808H06	CCMT0602	8	8	100	12	10	CS25061S	FT-7
SCGCR/L-1010H06		10	10	100	12	12		
SCGCR/L-1212H09	CCMT09T3	12	12	100	17	16	CS35090	FT-15
SCGCR/L-1616H09		16	16	100	18	20		
SCGCR/L-2020K12	CCMT1204	20	20	125	22	25	CS40115	FT-15
SCGCR/L-2525M12		25	25	150	25	32		

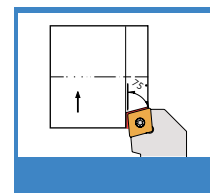
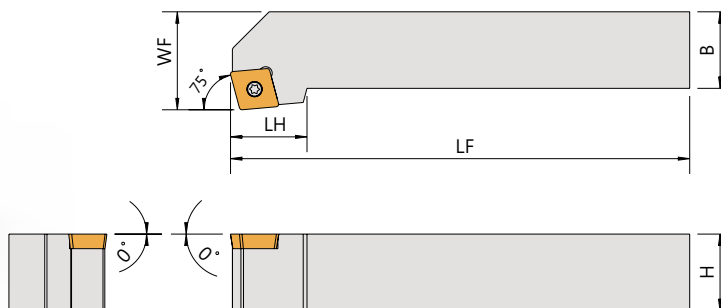
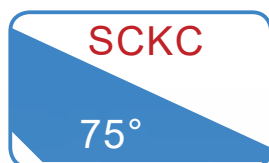

Order No.	Insert	Dimensions(mm)					Parts	Wrench
		柄高 H	柄寬 B	長度 LF	頭長 LH	工作寬度 WF		
SCKCR/L-2020K09	CCMT09T3	20	20	125	22	25	CS35090	FT-15
SCKCR/L-2525M09		25	25	150	25	32		
SCKCR/L-2020K12	CCMT1204	20	20	125	22	25	CS40115	FT-15
SCKCR/L-2525M12		25	25	150	25	32		



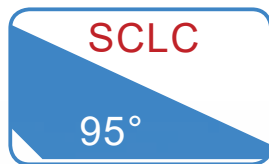

SCLC

95°

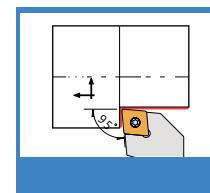
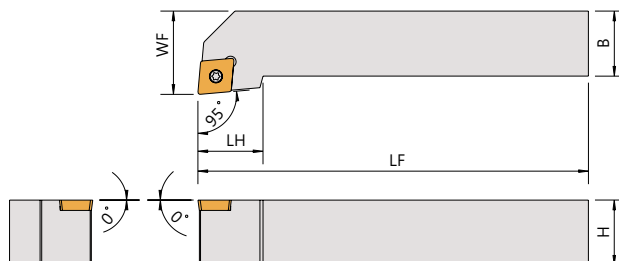

Order No.	Insert	Dimensions(mm)					Parts	Wrench
		柄高 H	柄寬 B	長度 LF	頭長 LH	工作寬度 WF		
SCLCR/L-0808H06	CCMT0602	8	8	100	12	10	CS25061S	FT-7
SCLCR/L-1010H06		10	10	100	12	12	CS25061S	FT-7
SCLCR/L-1212H06		12	12	100	17	16	CS25061S	FT-7
SCLCR/L-1212H09	CCMT09T3	12	12	100	17	16	CS35090	FT-15
SCLCR/L-1616H09		16	16	100	18	20	CS35090	FT-15
SCLCR/L-2020K09		20	20	125	22	25	CS35090	FT-15
SCLCR/L-2525M09		25	25	150	26	32	CS35090	FT-15
SCLCR/L-2020K12	CCMT1204	20	20	125	22	25	CS40115	FT-15
SCLCR/L-2525M12		25	25	150	26	32	CS40115	FT-15

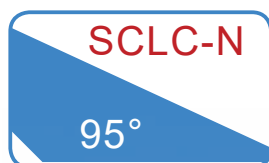

SCLC-N

95°

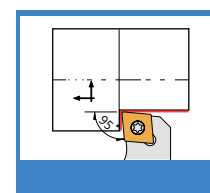
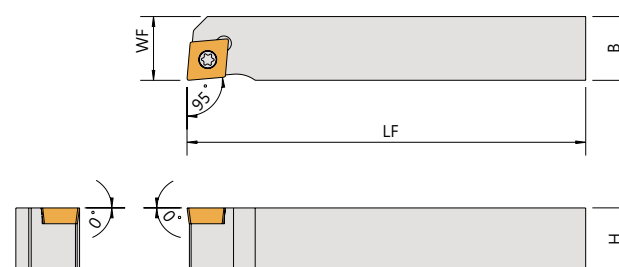

Order No.	Insert	Dimensions(mm)				Parts	Wrench
		柄高 H	柄寬 B	長度 LF	工作寬度 WF		
SCLCR/L-0808H06N	CCMT0602	8	8	100	8	CS25061S	FT-7
SCLCR/L-1010H06N		10	10	100	10	CS25061S	FT-7
SCLCR/L-0808K06N		8	8	125	8	CS25061S	FT-7
SCLCR/L-1010K06N		10	10	125	10	CS25061S	FT-7
SCLCR/L-1212H09N	CCMT09T3	12	12	100	12	CS35090	FT-15
SCLCR/L-1616H09N		16	16	100	16	CS35090	FT-15
SCLCR/L-1212K09N		12	12	125	12	CS35090	FT-15
SCLCR/L-1616K09N		16	16	125	16	CS35090	FT-15

**SCLC-S**  
95°

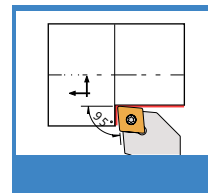
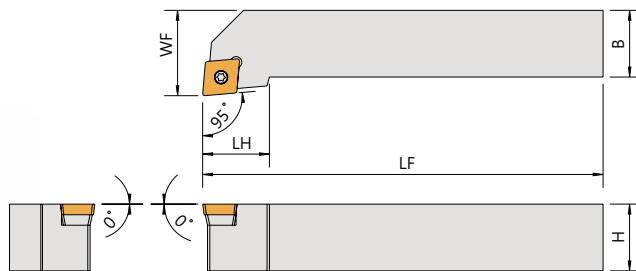

Order No.	Insert	Dimensions(mm)					Parts			Wrench	
		柄高 H	柄寬 B	長度 LF	頭長 LH	工作寬度 WF					
SCLCR/L-2020K09S	CCMT09T3	20	20	125	22	25	SMC-343	SN535	CS35119S	FT-15	LW035
SCLCR/L-2525M09S		25	25	150	25	32					
SCLCR/L-2020K12S	CCMT1204	20	20	125	22	25	SMC-453	SN630	CS40145	FT-15	LW040
SCLCR/L-2525M12S		25	25	150	25	32					

**SCMCN**  
**SCMCN-100**  
80°/100°

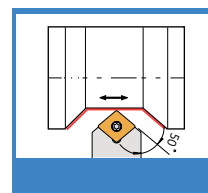
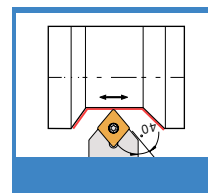
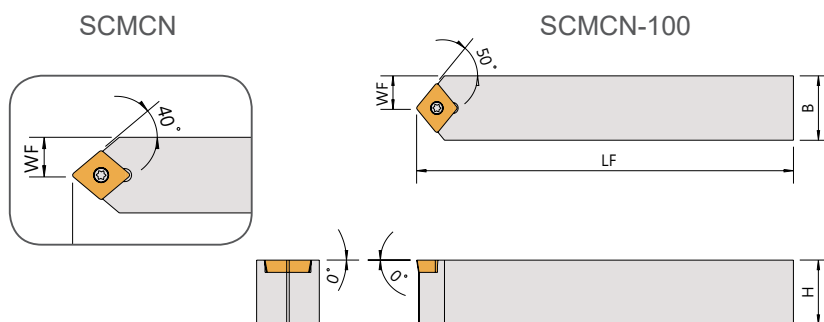

Order No.	Insert	Dimensions(mm)				Parts	Wrench
		柄高 H	柄寬 B	長度 LF	工作寬度 WF		
SCMCN-1212H09	CCMT09T3	12	12	100	6	CS35090	FT-15
SCMCN-1616H09		16	16	100	8		
SCMCN-2020K09		20	20	125	10		
SCMCN-2525M09		25	25	150	12.5		
SCMCN-2020K12	CCMT1204	20	20	125	10	CS40115	FT-15
SCMCN-2525M12		25	25	150	12.5		
SCMCN-1212H09-100	CCMT09T3	12	12	100	6	CS35090	FT-15
SCMCN-1616H09-100		16	16	100	8		
SCMCN-2020K09-100		20	20	125	10		
SCMCN-2525M09-100		25	25	150	12.5		
SCMCN-2020K12-100	CCMT1204	20	20	125	10	CS40115	FT-15
SCMCN-2525M12-100		25	25	150	12.5		

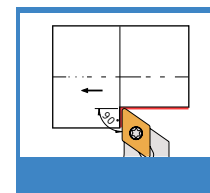
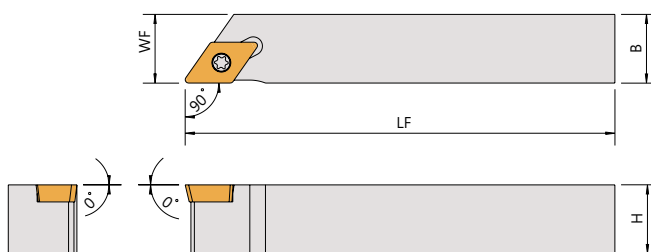
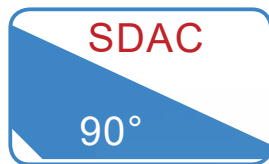

Order No.	Insert	Dimensions(mm)				Parts	Wrench
		柄高	柄寬	長度	工作寬度		
Right / Left		H	B	LF	WF		
SDACR/L-0808H07	DCMT0702	8	8	100	8	CS25061S	FT-7
SDACR/L-1010H07		10	10	100	10	CS25061S	FT-7
SDACR/L-1212H07		12	12	100	12	CS25061S	FT-7
SDACR/L-0808K07		8	8	125	8	CS25061S	FT-7
SDACR/L-1010K07		10	10	125	10	CS25061S	FT-7
SDACR/L-1212K07		12	12	125	12	CS25061S	FT-7
SDACR/L-1212H11	DCMT11T3	12	12	100	12	CS35095	FT-15
SDACR/L-1616H11		16	16	100	16	CS35095	FT-15
SDACR/L-1212K11		12	12	125	12	CS35095	FT-15
SDACR/L-1616K11		16	16	125	16	CS35095	FT-15
SDACR/L-2020K11		20	20	125	20	CS35095	FT-15
SDACR/L-2525M11		25	25	150	25	CS35095	FT-15

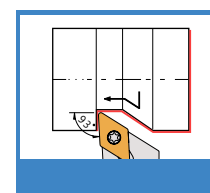
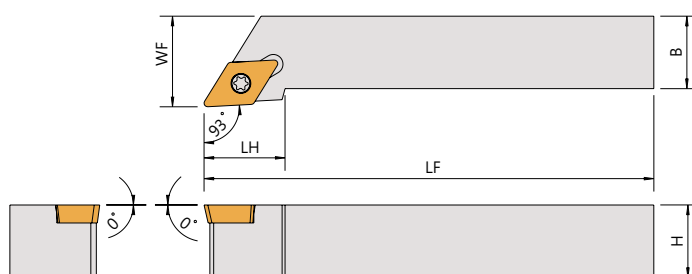
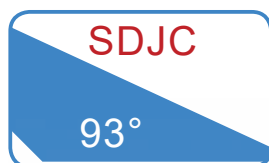

Order No.	Insert	Dimensions(mm)					Parts	Wrench
		柄高	柄寬	長度	頭長	工作寬度		
Right / Left		H	B	LF	LH	WF		
SDJCR/L-0808H07	DCMT0702	8	8	100	12.5	10	CS25061S	FT-7
SDJCR/L-1010H07		10	10	100	15	12	CS25061S	FT-7
SDJCR/L-1212H07		12	12	100	16	16	CS25061S	FT-7
SDJCR/L-1212H11	DCMT11T3	12	12	100	16	16	CS35095	FT-15
SDJCR/L-1616H11		16	16	100	18	20	CS35095	FT-15
SDJCR/L-2020K11		20	20	125	23	25	CS35095	FT-15
SDJCR/L-2525M11		25	25	150	27	32	CS35095	FT-15

SDJC-N  
SDJC-S

93°

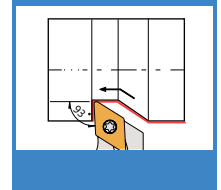

SDJC-N

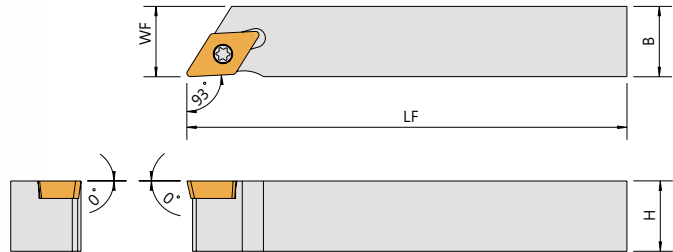

SDJC-S

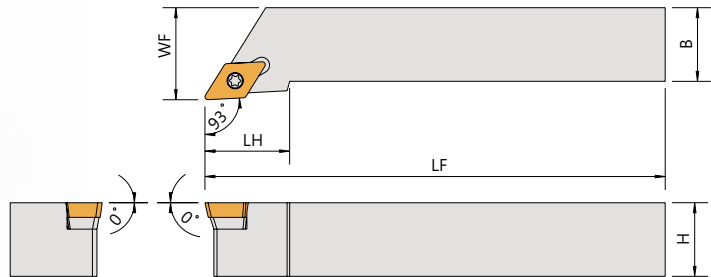

Order No.	Insert	Dimensions(mm)				Parts	Wrench
		柄高	柄寬	長度	工作寬度		
Right / Left		H	B	LF	WF		
SDJCR/L-0808H07N	DCMT0702	8	8	100	8	CS25061S	FT-7
SDJCR/L-1010H07N		10	10	100	10	CS25061S	FT-7
SDJCR/L-1212H07N		12	12	100	12	CS25061S	FT-7
SDJCR/L-0808K07N		8	8	125	8	CS25061S	FT-7
SDJCR/L-1010K07N		10	10	125	10	CS25061S	FT-7
SDJCR/L-1212K07N		12	12	125	12	CS25061S	FT-7
SDJCR/L-1212H11N	DCMT11T3	12	12	100	12	CS35095	FT-15
SDJCR/L-1616H11N		16	16	100	16	CS35095	FT-15
SDJCR/L-1212K11N		12	12	125	12	CS35095	FT-15
SDJCR/L-1616K11N		16	16	125	16	CS35095	FT-15

Order No.	Insert	Dimensions(mm)					Parts			Wrench	
		柄高	柄寬	長度	頭長	工作寬度					
Right / Left		H	B	LF	LH	WF					
SDJCR/L-2020K11S	DCMT11T3	20	20	125	22	25	SMD-343	SN535	CS35119S	FT-15	LW035
SDJCR/L-2525M11S		25	25	150	25	32					

**SDNCN**  
**SDNCN-S**  
62.5°

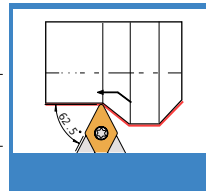
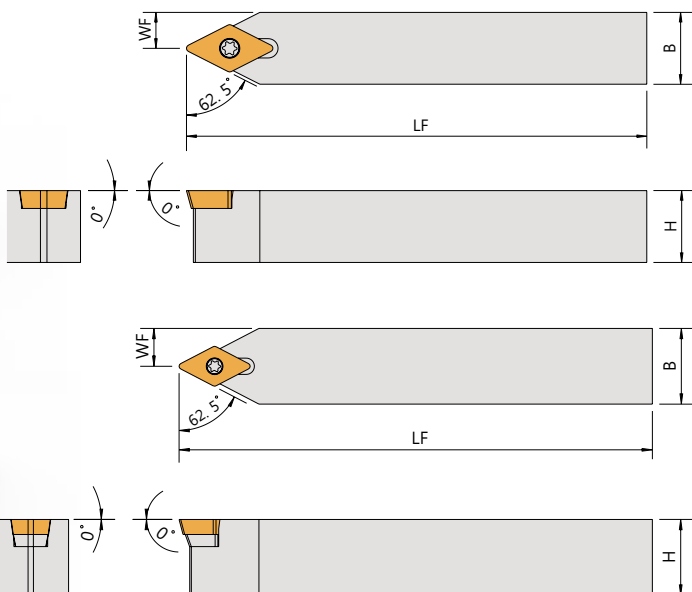

Order No.	Insert	Dimensions(mm)				Parts	Wrench
		柄高 H	柄寬 B	長度 LF	工作寬度 WF		
SDNCN-0808H07	DCMT0702	8	8	100	4	CS25061S	FT-7
SDNCN-1010H07		10	10	100	5	CS25061S	FT-7
SDNCN-1212H11	DCMT11T3	12	12	100	6	CS35095	FT-15
SDNCN-1616H11		16	16	100	8	CS35095	FT-15
SDNCN-2020K11		20	20	125	10	CS35095	FT-15
SDNCN-2525M11		25	25	150	12.5	CS35095	FT-15

Order No.	Insert	Dimensions(mm)				Parts			Wrench	
		柄高 H	柄寬 B	長度 LF	工作寬度 WF	刀片	刀柄	刀架	刀架	
SDNCN-2020K11S	DCMT11T3	20	20	125	25	SMD-343	SN535	CS35119S	FT-15	LW035
SDNCN-2525M11S		25	25	150	32					

▼ Inserts 刀片:

●: Stock / ◎: 1st Choice, ○: 2nd Choice, X: Not Recommend

Tolerance Class 精度	P	鋼 Carbon Steels		◎
	M	不鏽鋼 Stainless Steels		◎
M級	K	鑄鐵 Cast Iron	◎	

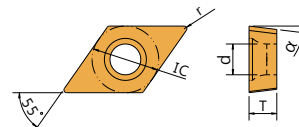

Specification 規格	Grade 材質		Dimensions(mm) 尺寸					
◎	HK1500	TN2000	IC	T	d	α	r	
DCMT11T304	●	●	12.7	3.97	4.4	7	0.4	
DCMT11T308	●	●	12.7	3.97	4.4	7	0.8	

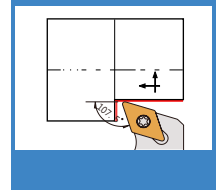
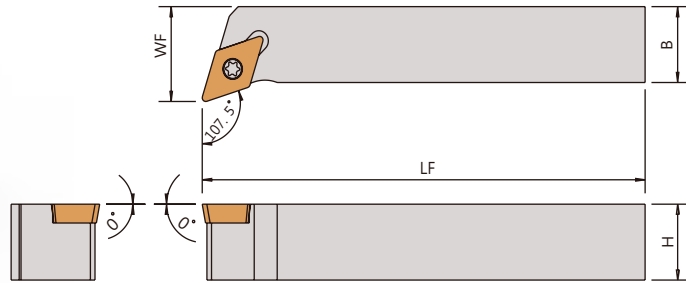
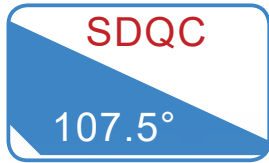

Order No.	Insert	Dimensions(mm)				Parts		Wrench	
		柄高 H	柄寬 B	長度 LF	工作寬度 WF				
SDQCR/L-1010H07	DCMT0702	10	10	100	12		CS25061S		FT-7
SDQCR/L-1212H11	DCMT11T3	12	12	100	16		CS35095		FT-15
SDQCR/L-1616H11		16	16	100	20		CS35095		FT-15
SDQCR/L-2020K11		20	20	125	25		CS35095		FT-15
SDQCR/L-2525M11		25	25	150	32		CS35095		FT-15

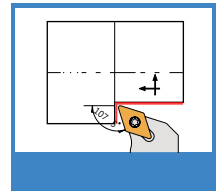
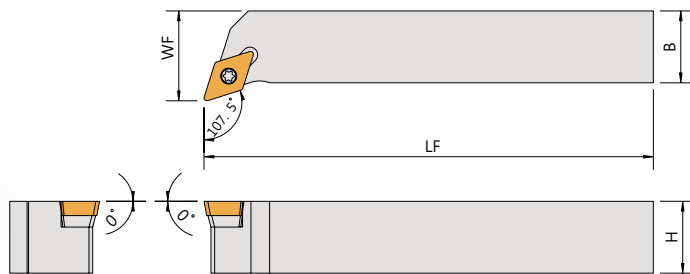
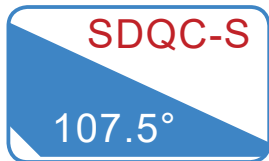

Order No.	Insert	Dimensions(mm)				Parts			Wrench	
		柄高 H	柄寬 B	長度 LF	工作寬度 WF					
SDQCR/L-2020K11S	DCMT11T3	20	20	125	25	SMD-343	SN535	CS35119S		FT-15
SDQCR/L-2525M11S		25	25	150	32					

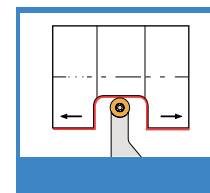
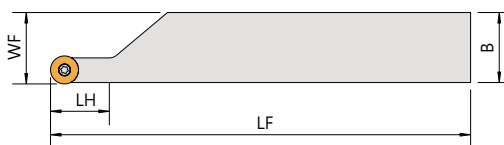
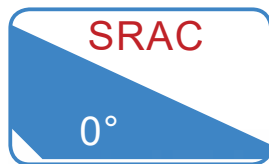

Order No.	Insert	Dimensions(mm)					Parts	Wrench
Right / Left		柄高	柄寬	長度	頭長	工作寬度		
		H	B	LF	LH	WF		
SRACR/L-1010H05	RCMT0502	10	10	100	10	10.5	CS22050	FT-7
SRACR/L-1212H05		12	12	100	10	12.3	CS22050	FT-7
SRACR/L-1616H05		16	16	100	10	16.3	CS22050	FT-7
SRACR/L-2020K05		20	20	125	10	20.3	CS22050	FT-7
SRACR/L-2525M05		25	25	150	10	25.3	CS22050	FT-7
SRACR/L-1212H06	RCMT0602	12	12	100	12	12.4	CS25061S	FT-7
SRACR/L-1616H06		16	16	100	12	16.4	CS25061S	FT-7
SRACR/L-2020K06		20	20	125	12	20.4	CS25061S	FT-7
SRACR/L-2525M06		25	25	150	12	25.4	CS25061S	FT-7
SRACR/L-1616H08	RCMT0803	16	16	100	16	16.4	CS30070	FT-10
SRACR/L-2020K08		20	20	125	16	20.4	CS30070	FT-10
SRACR/L-2525M08		25	25	150	16	25.4	CS30070	FT-10
SRACR/L-2020K1003	RCMT1003	20	20	125	20	20.4	CS30070	FT-10
SRACR/L-2525M1003		25	25	150	20	25.4	CS30070	FT-10
SRACR/L-3232S1003		32	32	250	20	32.5	CS30070	FT-10

Order No.	Insert	Dimensions(mm)					Parts			Wrench	
Right / Left		柄高	柄寬	長度	頭長	工作寬度					
		H	B	LF	LH	WF					
SRACR/L-2020K10T3S	RCMT10T3	20	20	125	20	20.4	SMR-1003	SN535	CS35119S	FT-15	LW035
SRACR/L-2525M10T3S		25	25	150	20	25.4	SMR-1003	SN535		FT-15	LW035
SRACR/L-3232S10T3S		32	32	250	20	32.5	SMR-1003	SN535		FT-15	LW035
SRACR/L-4040S10T3S		40	40	250	20	40.5	SMR-1003	SN535		FT-15	LW035
SRACR/L-2525M1204S	RCMT1204	25	25	150	20	25.5	SMR-1203	SN535		FT-15	LW035

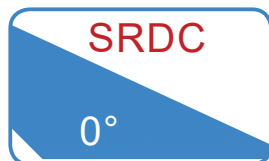

SRDC

0°

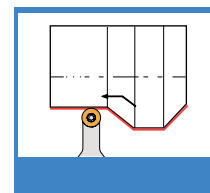
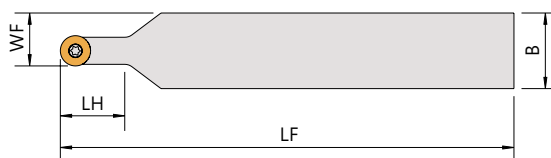

Order No.	Insert	Dimensions(mm)					Parts	Wrench
Right / Left		柄高	柄寬	長度	頭長	工作寬度		
		H	B	LF	LH	WF		
SRDCN-0808H06	RCMT0602	8	8	100	12	7	CS25061S	FT-7
SRDCN-1010H06		10	10	100	12	8	CS25061S	FT-7
SRDCN-1212H06		12	12	100	12	9	CS25061S	FT-7
SRDCN-1616H06		16	16	100	12	11	CS25061S	FT-7
SRDCN-1212H08	RCMT0803	12	12	100	16	9	CS30070	FT-10
SRDCN-1616H08		16	16	100	16	12	CS30070	FT-10
SRDCN-2020K08		20	20	125	16	14	CS30070	FT-10
SRDCN-2525M08		25	25	150	16	16.5	CS30070	FT-10
SRDCN-1616H1003	RCMT1003	16	16	100	20.3	13	CS30070	FT-10
SRDCN-2020K1003		20	20	125	20.3	15	CS30070	FT-10
SRDCN-2525M1003		25	25	150	20.3	17.5	CS30070	FT-10
SRDCN-3232P16	RCMT1606	32	32	170	32	24	CS50130	FT-20

Order No.	Insert	Dimensions(mm)					Parts	Wrench			
Right / Left		柄高	柄寬	長度	頭長	工作寬度					
		H	B	LF	LH	WF					
SRDCN-1616H10T3S	RCMT10T3	16	16	100	20.3	13	SMR-1003	SN535	CS35119S	FT-15	LW035
SRDCN-2020K10T3S		20	20	125	20.3	15	SMR-1003	SN535		FT-15	LW035
SRDCN-2525M10T3S		25	25	150	20.3	17.5	SMR-1003	SN535		FT-15	LW035
SRDCN-2020K1204S	RCMT1204	20	20	125	24	16	SMR-1203	SN535		FT-15	LW035
SRDCN-2525M1204S		25	25	150	24	18.5	SMR-1203	SN535		FT-15	LW035



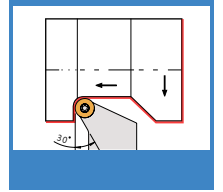
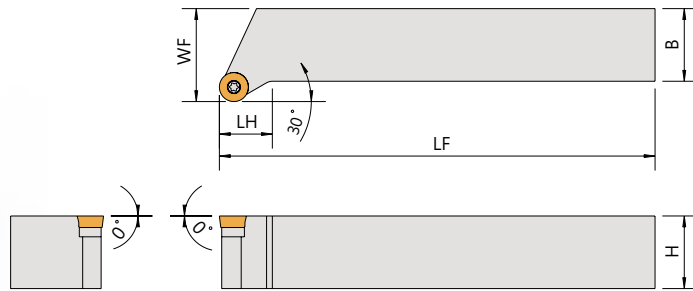
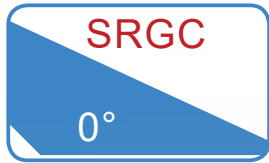

Order No.	Insert	Dimensions(mm)					Parts	Wrench
Right / Left		柄高	柄寬	長度	頭長	工作寬度		
		H	B	LF	LH	WF		
SRGCR/L-1212H05	RCMT0502	12	12	100	10.5	16	CS22050	FT-7
SRGCR/L-1616H05		16	16	100	10.5	20		
SRGCR/L-2020K05		20	20	125	12	25		
SRGCR/L-2525M05		25	25	150	15.5	32		
SRGCR/L-1212H06	RCMT0602	12	12	100	10.5	16	CS25061S	FT-7
SRGCR/L-1616H06		16	16	100	10.5	20		
SRGCR/L-2020K06		20	20	125	12.5	25		
SRGCR/L-2525M06		25	25	150	16	32		
SRGCR/L-1616H08	RCMT0803	16	16	100	11.5	20	CS30070	FT-10
SRGCR/L-2020K08		20	20	125	14	25		
SRGCR/L-2525M08		25	25	150	17	32		
SRGCR/L-2020K1003	RCMT1003	20	20	125	15	25	CS30070	FT-10
SRGCR/L-2525K1003		25	25	125	18.5	32		

Order No.	Insert	Dimensions(mm)					Parts	Wrench			
Right / Left		柄高	柄寬	長度	頭長	工作寬度					
		H	B	LF	LH	WF					
SRGCR/L-2020K10T3S	RCMT10T3	20	20	125	15	25	SMR-1003	SN535	CS35119S	FT-15	LW035
SRGCR/L-2525M10T3S		25	25	150	18.5	32					

Order No.	Insert	Dimensions(mm)					Parts	Wrench			
Right / Left		柄高	柄寬	長度	頭長	工作寬度					
		H	B	LF	LH	WF					
SRGCR/L-1616H1204S	RCMT1204	16	16	100	16	20	SMR-1203	SN535	CS35119S	FT-15	LW035
SRGCR/L-2020K1204S		20	20	125	16	25					
SRGCR/L-2525M1204S		25	25	150	20	32					
SRGCR/L-3232M1204S		32	32	150	23	40					

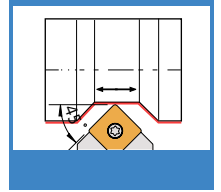
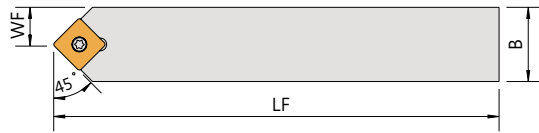
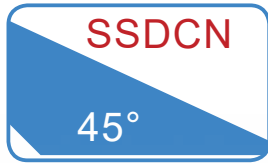

Order No.	Insert	Dimensions(mm)				Parts	Wrench
Right / Left		柄高 H	柄寬 B	長度 LF	工作寬度 WF		
SSDCN-1212H09	SCMT09T3	12	12	100	6	CS40090	FT-15
SSDCN-1616H09		16	16	100	8	CS40090	FT-15
SSDCN-2020K09		20	20	125	10	CS40090	FT-15
SSDCN-2525M09		25	25	150	12.5	CS40090	FT-15
SSDCN-1616H12	SCMT1204	16	16	100	8	CS40115	FT-15
SSDCN-2020K12		20	20	125	10	CS40115	FT-15
SSDCN-2525M12		25	25	150	12.5	CS40115	FT-15

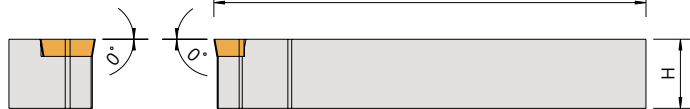
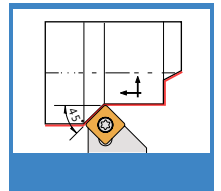
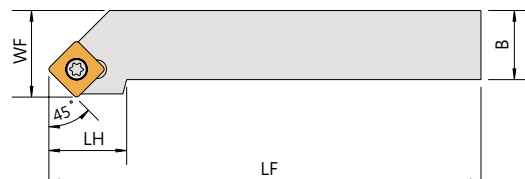
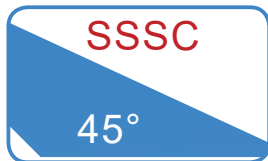

Order No.	Insert	Dimensions(mm)					Parts	Wrench
Right / Left		柄高 H	柄寬 B	長度 LF	頭長 LH	工作寬度 WF		
SSSCR/L-1212H09	SCMT09T3	12	12	100	20	16	CS40090	FT-15
SSSCR/L-1616H09		16	16	100	20	20	CS40090	FT-15
SSSCR/L-1616H12	SCMT1204	16	16	100	26	20	CS40115	FT-15

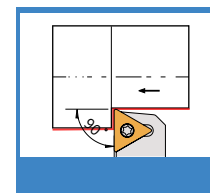
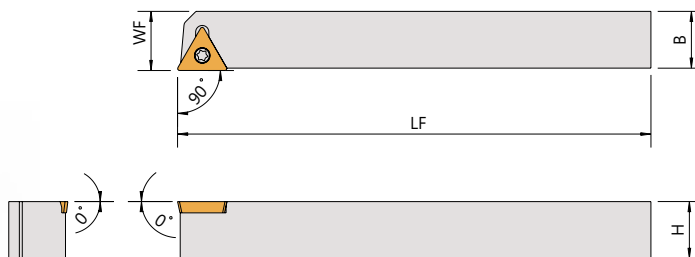
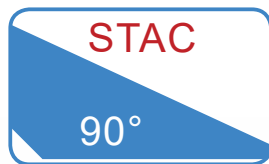

Order No.	Insert	Dimensions(mm)				Parts	Wrench
Right / Left		柄高 H	柄寬 B	長度 LF	工作寬度 WF		
STACR/L-0808H09	TCMT0902	8	8	100	8.5	CS22050	FT-7
STACR/L-1010H09		10	10	100	10.5	CS22050	FT-7
STACR/L-1212H11	TCMT1102	12	12	100	12.5	CS25061S	FT-7
STACR/L-1616H11		16	16	100	16.5	CS25061S	FT-7

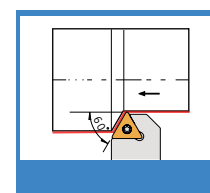
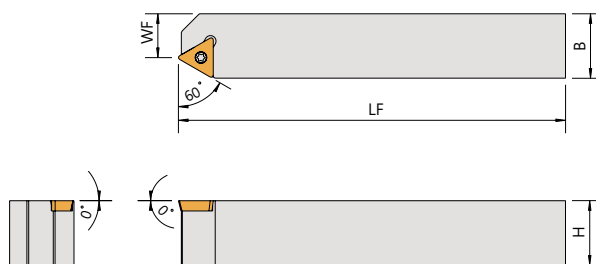
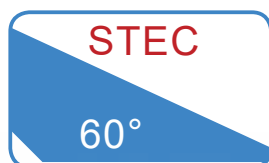

Order No.	Insert	Dimensions(mm)				Parts	Wrench
Right / Left		柄高 H	柄寬 B	長度 LF	工作寬度 WF		
STECR/L-1616H11	TCMT1102	16	16	100	10.5	CS25061S	FT-7
STECR/L-2020K11		20	20	125	14.5	CS25061S	FT-7
STECR/L-2525M11		25	25	150	19.5	CS25061S	FT-7
STECR/L-2020K16	TCMT16T3	20	20	125	12	CS40090	FT-15
STECR/L-2525M16		25	25	150	17	CS40090	FT-15

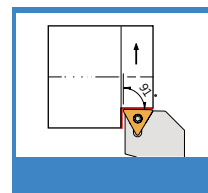
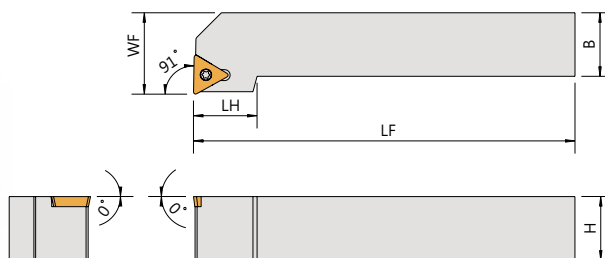
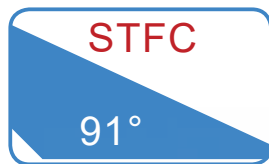

Order No.	Insert	Dimensions(mm)					Parts	Wrench
Right / Left		柄高 H	柄寬 B	長度 LF	頭長 LH	工作寬度 WF		
STFCR/L-0808H09	TCMT0902	8	8	100	12	10	CS22050	FT-7
STFCR/L-1010H09		10	10	100	12	12	CS22050	FT-7
STFCR/L-1212H11	TCMT1102	12	12	100	17	16	CS25061S	FT-7
STFCR/L-1616H11		16	16	100	18	20	CS25061S	FT-7
STFCR/L-2020K16	TCMT16T3	20	20	125	23	25	CS40090	FT-15
STFCR/L-2525M16		25	25	150	26	32	CS40090	FT-15

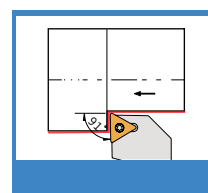
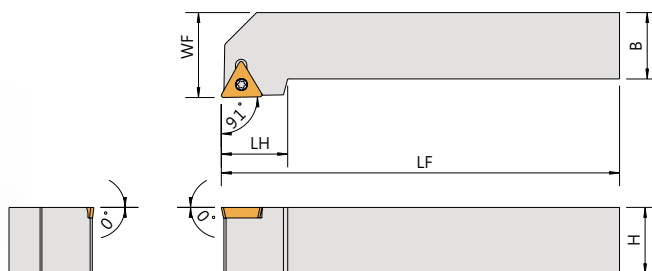
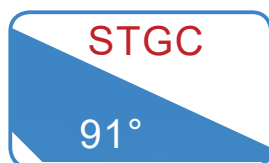

Order No.	Insert	Dimensions(mm)					Parts	Wrench
Right / Left		柄高 H	柄寬 B	長度 LF	頭長 LH	工作寬度 WF		
STGCR/L-1212H11	TCMT1102	12	12	100	17	16	CS25061S	FT-7
STGCR/L-1616H11		16	16	100	18	20	CS25061S	FT-7
STGCR/L-2020K16	TCMT16T3	20	20	125	22	25	CS40090	FT-15
STGCR/L-2525M16		25	25	150	25	32	CS40090	FT-15

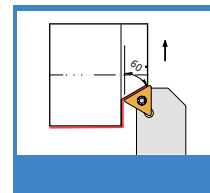
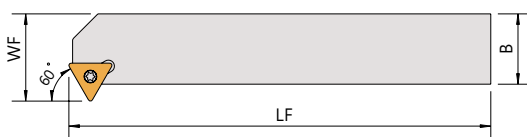
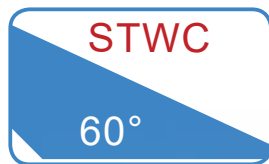

Order No.	Insert	Dimensions(mm)				Parts	Wrench
		柄高 H	柄寬 B	長度 LF	工作寬度 WF		
STWCR/L-1212H11	TCMT1102	12	12	100	15.3	CS25061S	FT-7
STWCR/L-1616H11		16	16	100	19.3	CS25061S	FT-7
STWCR/L-2020K11		20	20	125	23.3	CS25061S	FT-7
STWCR/L-2525M11		25	25	150	28.3	CS25061S	FT-7
STWCR/L-1616H16	TCMT16T3	16	16	100	21	CS40090	FT-15
STWCR/L-2020K16		20	20	125	26	CS40090	FT-15
STWCR/L-2525M16		25	25	150	31	CS40090	FT-15
STWCR/L-3232P16		32	32	170	38	CS40090	FT-15

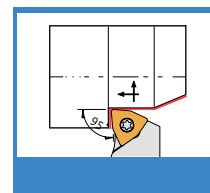
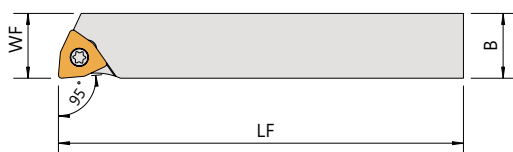
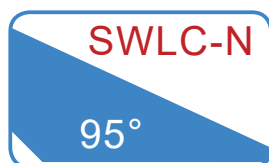

▼ Recommended Inserts 刀片建議品牌 : SUMITOMO

Order No.	Insert	Dimensions(mm)				Parts	Wrench
		柄高 H	柄寬 B	長度 LF	工作寬度 WF		
SWLCR/L-1212H06N	WCMT06T3	12	12	100	12	CS35091	FT-15
SWLCR/L-1616H06N		16	16	100	16	CS35091	FT-15

**SVHB  
SVHC**  
107.5°

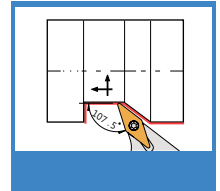
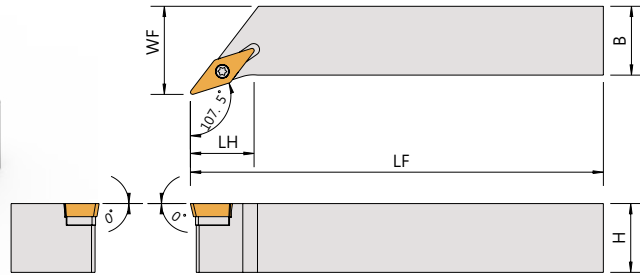

Order No.	Insert	Dimensions(mm)					Parts			Wrench	
		柄高 H	柄寬 B	長度 LF	頭長 LH	工作寬度 WF					
SVHBR/L-1212F11	VBMT1103	12	12	80	13	16	-	-	CS25061S	FT-7	-
SVHBR/L-1616H11		16	16	100	13	20	-	-			-
SVHBR/L-2020K11		20	20	125	16.5	25	-	-			-
SVHBR/L-2020K16	VBMT1604	20	20	125	17	25	SMV-321	SN535	CS35119S	FT-15	LW035
SVHBR/L-2525M16		25	25	150	23	32					
SVHBR/L-3232P16		32	32	170	26.5	40					
SVHCR/L-1212F11	VCMT1103	12	12	80	13	16	-	-	CS25061S	FT-7	-
SVHCR/L-1616H11		16	16	100	13	20	-	-			-
SVHCR/L-2020K11		20	20	125	16.5	25	-	-			-
SVHCR/L-2020K16	VCMT1604	20	20	125	17	25	SMV-321	SN535	CS35119S	FT-15	LW035
SVHCR/L-2525M16		25	25	150	23	32					
SVHCR/L-3232P16		32	32	170	26.5	40					

**SVJB**  
**SVJB-N**  
93°

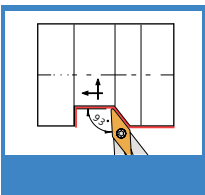
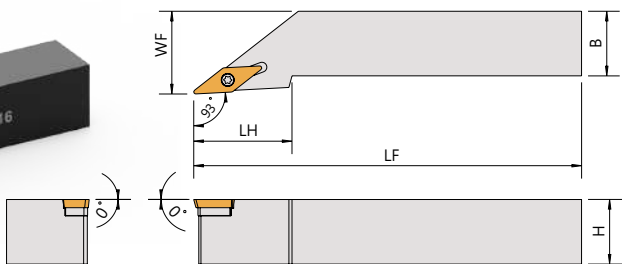

Order No.	Insert	Dimensions(mm)					Parts			Wrench	
Right / Left		柄高	柄寬	長度	頭長	工作寬度					
		H	B	LF	LH	WF					
SVJBR/L-2020K11	VBMT1103	20	20	125	22	25	-	-	CS25061S	FT-7	-
SVJBR/L-2020K16	VBMT1604	20	20	125	33	25	SMV-321	SN535	CS35119S	FT-15	LW035
SVJBR/L-2525M16		25	25	150	38	32	SMV-321	SN535		FT-15	LW035
SVJBR/L-1212H11N	VBMT1103	12	12	100	-	12	-	-	CS25061S	FT-7	-
SVJBR/L-1616H11N		16	16	100	-	16	-	-	CS25061S	FT-7	-
SVJBR/L-1212K11N		12	12	125	-	12	-	-	CS25061S	FT-7	-
SVJBR/L-1616K11N		16	16	125	-	16	-	-	CS25061S	FT-7	-
SVJBR/L-1616H16N	VBMT1604	16	16	100	-	16	SMV-321	SN535	CS35119S	FT-15	LW035

**SVJC**  
**SVJC-N**  
93°

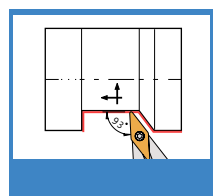
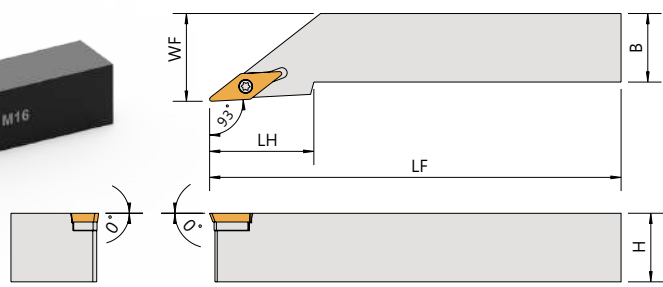

Order No.	Insert	Dimensions(mm)					Parts			Wrench	
Right / Left		柄高	柄寬	長度	頭長	工作寬度					
		H	B	LF	LH	WF					
SVJCR/L-2020K11	VCMT1103	20	20	125	33	25	-	-	CS25061S	FT-7	-
SVJCR/L-2525M11		25	25	150	38	32	-	-	CS25061S	FT-7	-
SVJCR/L-2020K16	VCMT1604	20	20	125	33	25	SMV-321	SN535	CS35119S	FT-15	LW035
SVJCR/L-2525M16		25	25	150	38	32	SMV-321	SN535		FT-15	LW035
SVJCR/L-1010H11N	VCMT1103	10	10	100	-	10	-	-	CS25061S	FT-7	-
SVJCR/L-1212H11N	VCMT1103	12	12	100	-	12	-	-	CS25061S	FT-7	-
SVJCR/L-1616H11N	VCMT1103	16	16	100	-	16	-	-	CS25061S	FT-7	-
SVJCR/L-1010K11N	VCMT1103	10	10	125	-	10	-	-	CS25061S	FT-7	-
SVJCR/L-1212K11N	VCMT1103	12	12	125	-	12	-	-	CS25061S	FT-7	-
SVJCR/L-1616K11N	VCMT1103	16	16	125	-	16	-	-	CS25061S	FT-7	-
SVJCR/L-1616H16N	VCMT1604	16	16	100	-	16	SMV-321	SN535	CS35119S	FT-15	LW035

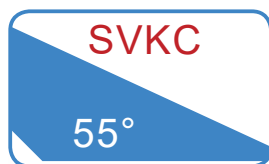

SVKC

55°

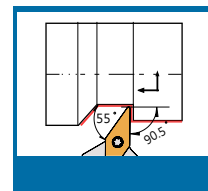
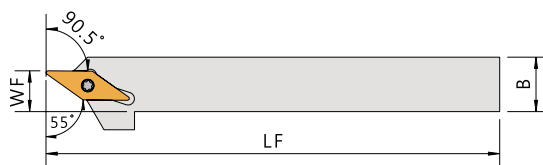

Order No.	Insert	Dimensions(mm)				Parts			Wrench	
Right / Left		柄高 H	柄寬 B	長度 LF	工作寬度 WF					
SVKCR-1212H11	VCMT1103	12	12	100	9	-	-	CS25061S	FT-7	-



SVPC

117.5°

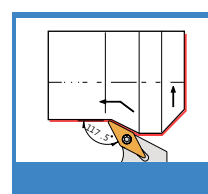
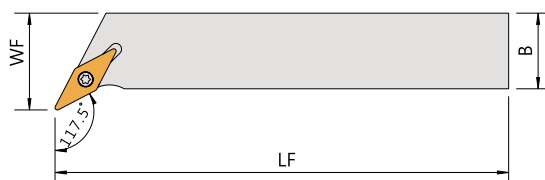
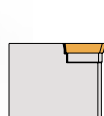

Order No.	Insert	Dimensions(mm)				Parts			Wrench	
Right / Left		柄高 H	柄寬 B	長度 LF	工作寬度 WF					
SVPCR/L-1010H11	VCMT1103	10	10	100	14.5	-	-	CS25061S	FT-7	-
SVPCR/L-1212H11		12	12	100	16.5	-	-	CS25061S	FT-7	-
SVPCR/L-1616H11		16	16	100	20.5	-	-	CS25061S	FT-7	-
SVPCR/L-2020K16	VCMT1604	20	20	125	25	SMV-321	SN535	CS35119S	FT-15	LW035
SVPCR/L-2525M16		25	25	150	32	SMV-321	SN535		FT-15	LW035



SVQB  
SVQC

107.5°/117.5°/127.5°

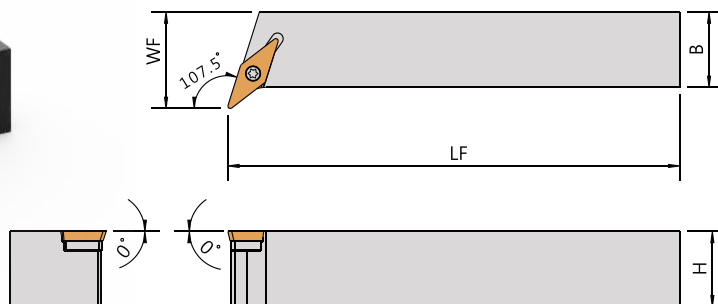
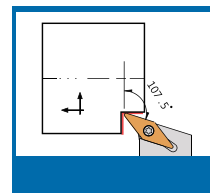
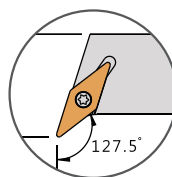
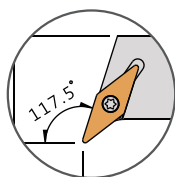

※SVQB/SVQC 標準角度: 107.5°

Order No.	Insert	Dimensions(mm)					Parts			Wrench	
		柄高 H	柄寬 B	長度 LF	頭長 LH	工作寬度 WF					
SVQBR/L-2020K16	VBMT1604	20	20	125	-	25	SMV-321	SN535	CS35119S	FT-15	LW035
SVQBR/L-2525M16		25	25	150	-	32					
SVQCR/L-2020K16	VCMT1604	20	20	125	-	25	SMV-321	SN535	CS35119S	FT-15	LW035
SVQCR/L-2525M16		25	25	150	-	32					

Order No.	Insert	Dimensions(mm)					Parts			Wrench	
		柄高 H	柄寬 B	長度 LF	頭長 LH	工作寬度 WF					
SVQBR/L-2020K16-117.5	VBMT1604	20	20	125	-	25	SMV-321	SN535	CS35119S	FT-15	LW035
SVQBR/L-2525M16-117.5		25	25	150	-	32					
SVQCR/L-2020K16-117.5	VCMT1604	20	20	125	-	25	SMV-321	SN535	CS35119S	FT-15	LW035
SVQCR/L-2525M16-117.5		25	25	150	-	32					

Order No.	Insert	Dimensions(mm)					Parts			Wrench	
		柄高 H	柄寬 B	長度 LF	頭長 LH	工作寬度 WF					
SVQBR/L-2020K16-127.5	VBMT1604	20	20	125	-	25	SMV-321	SN535	CS35119S	FT-15	LW035
SVQBR/L-2525M16-127.5		25	25	150	-	32					
SVQCR/L-2020K16-127.5	VCMT1604	20	20	125	-	25	SMV-321	SN535	CS35119S	FT-15	LW035
SVQCR/L-2525M16-127.5		25	25	150	-	32					

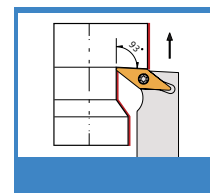
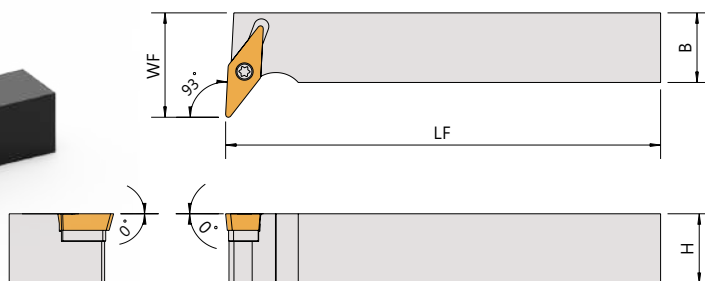
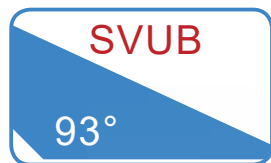

Order No.	Insert	Dimensions(mm)				Parts			Wrench	
		柄高 H	柄寬 B	長度 LF	工作寬度 WF					
SVUBR/L-2020K16	VBMT1604	20	20	125	30	SMV-321	SN535	CS35119S	FT-15	LW035
SVUBR/L-2525M16		25	25	150	35	SMV-321	SN535	CS35119S	FT-15	LW035

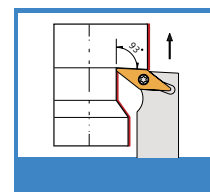
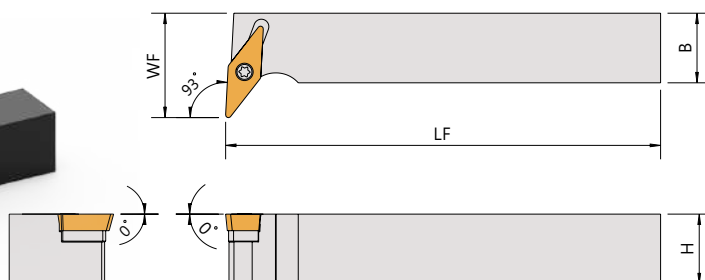
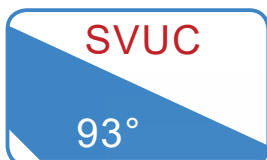

Order No.	Insert	Dimensions(mm)				Parts			Wrench	
		柄高 H	柄寬 B	長度 LF	工作寬度 WF					
SVUCR/L-1616H11	VCMT1103	16	16	100	24	-	-	CS25061S	FT-7	-
SVUCR/L-1616H16	VCMT1604	16	16	100	30	SMV-321	SN535	CS35119S	FT-15	LW035
SVUCR/L-2020K16		20	20	125	30	SMV-321	SN535		FT-15	LW035
SVUCR/L-2525M16		25	25	150	35	SMV-321	SN535		FT-15	LW035
SVUCR/L-3225S16		32	25	250	32	SMV-321	SN535		FT-15	LW035

**SVVBN**  
72.5°

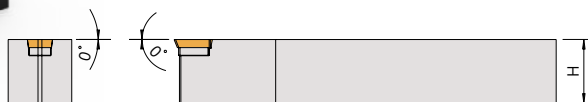
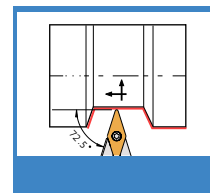
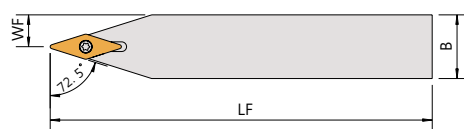

Order No.	Insert	Dimensions(mm)				Parts			Wrench	
		柄高 H	柄寬 B	長度 LF	工作寬度 WF					
SVVBN-2020K11	VBMT1103	20	20	125	10	-	-	CS25061S	FT-7	-
SVVBN-2525M11		25	25	150	12.5	-	-	CS25061S	FT-7	-
SVVBN-2020K16	VBMT1604	20	20	125	10	SMV-321	SN535	CS35119S	FT-15	LW035
SVVBN-2525M16		25	25	150	12.5	SMV-321	SN535		FT-15	LW035

**SVVC**  
72.5°

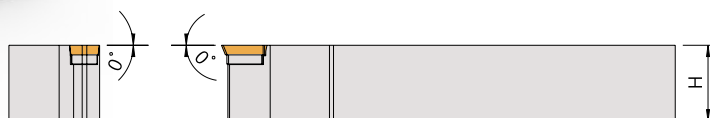
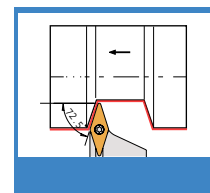
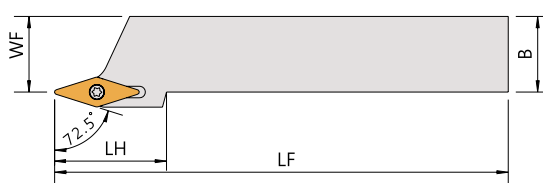

Order No.	Insert	Dimensions(mm)					Parts			Wrench	
		柄高 H	柄寬 B	長度 LF	頭長 LH	工作寬度 WF					
SVVCR/L-2020K16	VCMT1604	20	20	125	37	20	SMV-321	SN535	CS35119S	FT-15	LW035
SVVCR/L-2525M16		25	25	150	37	25	SMV-321	SN535	CS35119S	FT-15	LW035

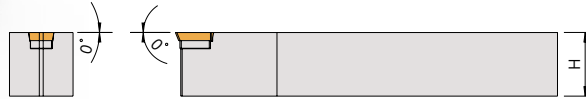
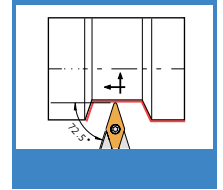
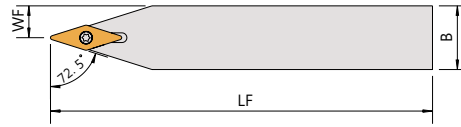
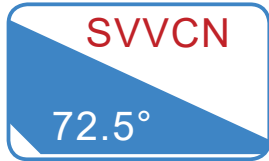

Order No.	Insert	Dimensions(mm)				Parts			Wrench	
		柄高 H	柄寬 B	長度 LF	工作寬度 WF					
SVVCN-0808H11	VCMT1103	8	8	100	4	-	-	CS25061S	FT-7	-
SVVCN-1010H11		10	10	100	5	-	-	CS25061S	FT-7	-
SVVCN-1212H11		12	12	100	6	-	-	CS25061S	FT-7	-
SVVCN-1616H11		16	16	100	8	-	-	CS25061S	FT-7	-
SVVCN-1616H16	VCMT1604	16	16	100	8	SMV-321	SN535	CS35119S	FT-15	LW035
SVVCN-2020K16		20	20	125	10	SMV-321	SN535		FT-15	LW035
SVVCN-2525M16		25	25	150	12.5	SMV-321	SN535		FT-15	LW035