

JAINNHER®

CENTERLESS GRINDING MACHINE More Efficient Solutions For Grinding



41Q5482

JAINNHER[®] Company Introduction

Our Philosophy

Since 1982 JAINNHER MACHINE CO., LTD. has excelled in the development of centerless grinding technology. Dedicated to advancements in diversity and automation, we are constantly offering new and improved machinery. Our main products include centerless, cylindrical and internal grinding machines as well as various NC & CNC automatic loading and unloading systems. In the machinery industry, precision requirements are the highest for grinding machines. Accordingly, we implement stringent quality control throughout our production process. An abundance of technical experience and advancement backs our maxim, "Exceeding the Pursuit of Excellence." As we strive forth in R&D, our clients reap the benefits of exponential refinements. Grinding requirements continue to rise, and satisfied customers have come to expect that our first class products equip them to conquer the demands they face in the industry.

Company Summary

Established: November, 1982

Factory: No. 333, 28th Rd., Taichung Industrial Park, Taichung, Taiwan 407

Capital: US\$4 million

Employees: 120

Land area: 17,000 m²

Plant area: 11,130 m²



Main Products

- Centerless Grinding Machine
JHC-12BN / 12S / 12H / 18 / 18S / 18H / 18A / 18AS / 18AH / 18B / 18BS / 18BH / 20 / 20S 20H / 24H (2408 / 2410 / 2412)
JHC-2408T grinding - regulating wheel both side feeding
Offer options CNC or NC Automation related accessories.
- NC / CNC Internal Grinding Machine
JHI-150NC / CNC
JHI-3012NC / CNC
JHI-3006NC / CNC
- CNC Vertical Grinding Machine
JHV-1008 CNC
- Cylindrical Grinding Machine
JHU-2706 / 3506 / 2710 / 3510 / 2715 / 3515 / 2720 / 3520 Offer options CNC or NC Automation related accessories.
- CNC Plunge / Angular Grinding Machine
JHP-2003 / 3506 / 3510 / 4006 / 4010
JHA-2003 / 3505 / 3508 / 4005 / 4008
- CNC Double Spindle Grinding Machine
JHD-3205IO / 3205II / 3205IU / 1503IO
- Center Hole Grinding Machine
JHG-1510 / 1015 / 1020

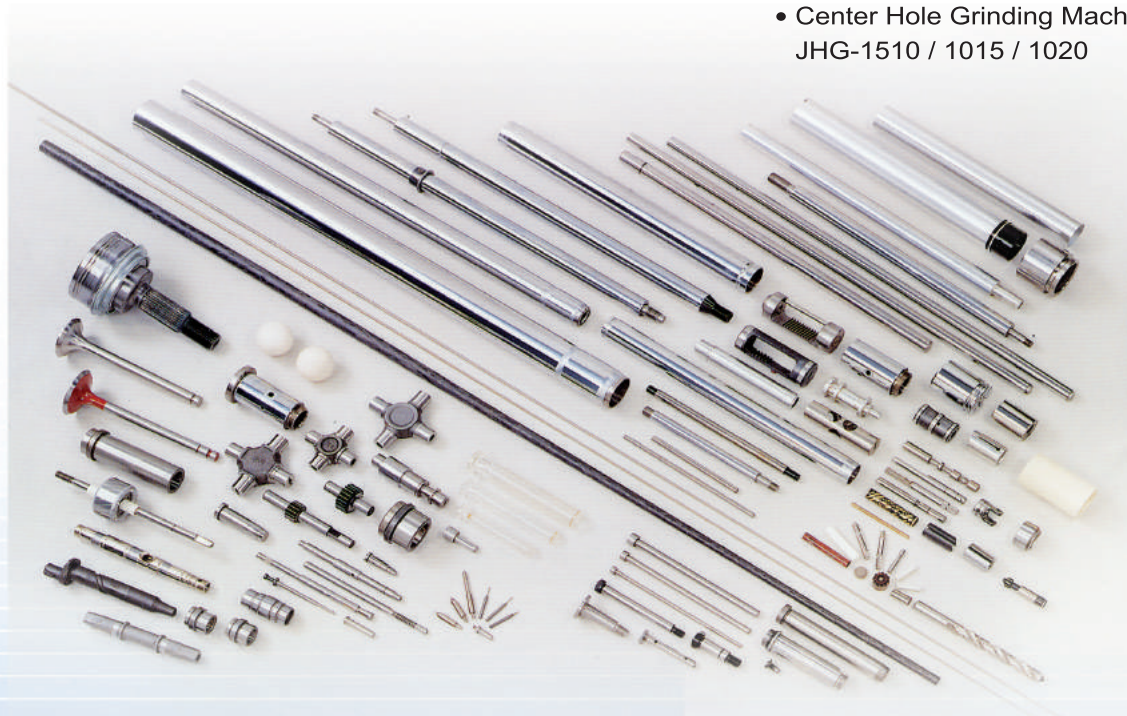

Sales Network



Features

1. Main Structure of Machines

They are cast of high grade FC-30 iron, melted by advanced induction furnace, then cast in resin cores. In order to ensure stability and rigidity, they are heat-treated with normalizing procedure prior to machining.

2. Spindle

2.1 Hydrostatic Bearings

Precision ground Hydrostatic Bearings: Substantial decrease in heat deformation associated with Hydrodynamic bearings. Minimal friction, lateral displacement, and pressure. Extended tool life under heavy cut loads.

Grinding Wheel Spindle: The Grinding Wheel Spindle runs on hydrostatic bearings with a high pressure oil film for added precision under heavy loads. Substantially reduces wear while prolonging spindle trueness. SNCM-210H carbon steel hardened beyond HRC60, yielding high torsion resistance.

2.2 Hydrodynamic Bearings

They are made of SNCM-220H Ni-Cr-Mo alloy steel and case-hardened, carbonized, then computerized sub-zero degree treated, to surface hardness over HRC 62 at 1.0mm depth. Core hardness is kept at about HRC 25-30 to ensure consistency of high precision grinding operation. Spindles withstand high torsion and have a long and lasting life. They are made of KJ-4 alloy bushing metal with a three point hydraulic cycle system. The semi-hydraulic float spindle is protected by an oil membrane which results in minimal contact friction. This device is specially designed for high speed and heavy load operation.

3. Regulating Wheel Drive

A Japanese servo motor provides control of speeds from 10 to 250RPM and is used for the regulating wheel which can be adjusted to ideal linear speeds. When the diameter of the regulating wheel changes the same linear speed can still be maintained so as grind the best quality products. The motor is driven by a timing-belt to reduce vibration and noise. Since the motor housing and spindle housing are joined together as an integrated body, when the regulating wheel tilts the motor also follows. This completely overcomes problems caused by unparallelism and torsion of belt pulleys and the belts.

4. Spindle Oil Circulation

4.1 Hydrodynamic

There is a variable vane type oil pump for the hydraulic dressing and enforced spindle oil circulation. The oil tank is located outside of the machine for easy maintenance. Two layers of filter plus a pressure regulator ensure the cleanliness of spindle oil and the consistency of oil film thickness, thus extending the service life of the wheel spindle and the steadiness of accuracy.

4.2 Hydrostatic

Hydraulic pump for grinding wheel head and spindle motor driver with sensing function. When press wheel start button, before oil reach alloy bearing will through pressure detect switch, if pressure is not enough, it cannot push the switch, the spindle will not start. Therefore, when pressure is not enough or oil pipe blocked, pressure switch will stop the wheel spindle automatically. It will protect the wheel spindle and alloy bearing. (Hydraulic pump motor for 12 is 2HP, 18, 20 and 24 is 3HP)

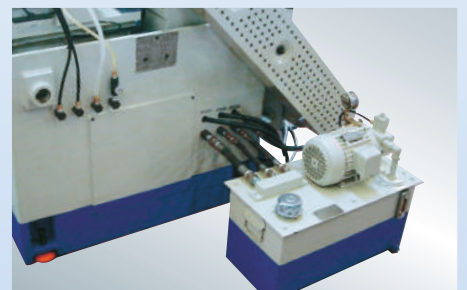
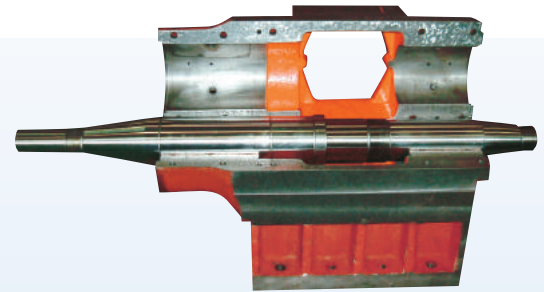
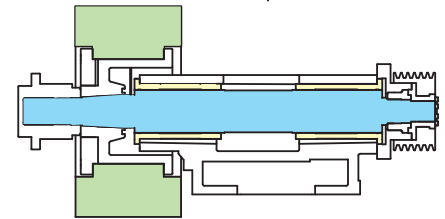
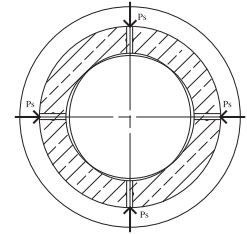

5. Regulator

Grinding wheel spindle with high pressure hydrostatic device, apply a regulator on entrance for adjusting high pressure oil to support radial center. The setting work pressure is 20 kg/cm²

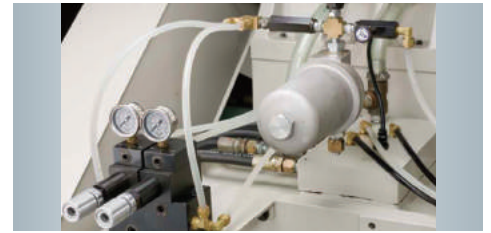

6. Slide Device

The lower slide consists of two internally mounted V-shaped slides and cuneiform protector to ensure smooth movement, stable operation and prevent the entering of debris or liquid from the working environment. The swivel slides on a dovetail flute and swivels ±5 degrees. There is a fine tuning hand wheel for precise adjustment. The accuracy per calibration is 0.001mm in diameter for high precision and easy operation.

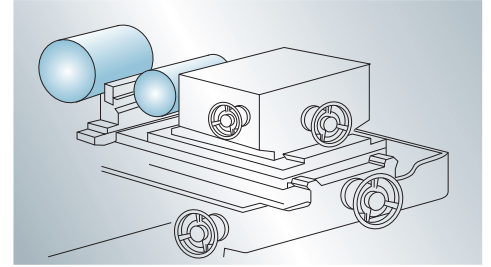

7. Wheel Dressing Device

The device is made of FC-30 cast iron and normalized then precisely ground. It is driven by a hydraulic system with a step-less speed regulator for easy and steady dressing. There is a safety handle for emergency purposes. In order to upgrade the straightness and the surface finish on through-feed grinding of long work pieces, please adjust the angle of the dressing device (swivels ±5 degrees). The regulating wheel should be adjusted to resemble a concave barrel to increase contact length while grinding.

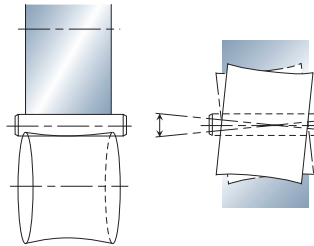

8. Grinding Accuracy

- Workpiece: $\varnothing 2 \times 20 \ell$
- Grinding wheel WA 1000#
- Metal: SUJ-2
- Machine: JHC-18
- Hardness: HRC-62

CUT OFF=0.25 mm
 TRAVERSING LENGTH=1.0 mm
 MAG=10000

Ra=0.02 μm RMS=0.02 μm
 RMax=0.28 μm Rt=0.22 μm
 Rz=0.24 μm Rtm=0.20 μm

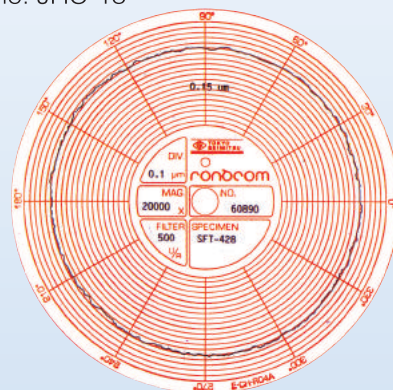

Roundness



Quality of Our Machines

The performance of all our machines is strictly inspected for roundness, straightness and surface roughness on standard work pieces before delivery.

9. Operation Applications

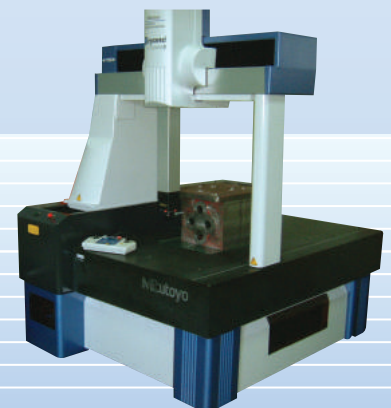
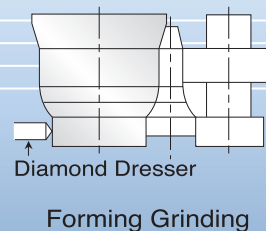
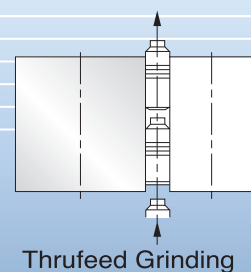
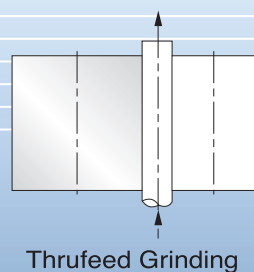
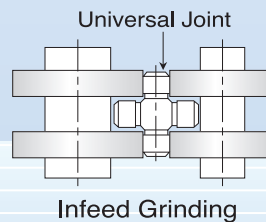
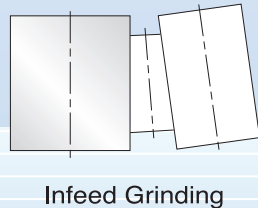
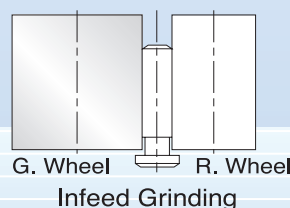

CNC Coordinate Measuring Machine

	JHC-12BN	JHC-12H JHC-12S
Standard work rest (dia.)	ø1~ø25 mm	
Special work rest (dia.)	ø25~ø40 mm	
Grinding wheel size (dia. x width x hole)	ø305 x 150 x ø120	
Regulating wheel size (dia. x width x hole)	ø205 x 150 x ø90	
Grinding wheel speed	1900 R.P.M	
Regulating wheel speed	20-337 R.P.M. (7 steps)	10-300 R.P.M variable speed
Grinding wheel motor	7.5 HP	
Regulating wheel motor	1 HP	2 HP
Hydraulic pump motor	1 HP (+ 2 HP for H type)	
Coolant pump motor	1/8 HP	
Regulating wheel feed on handwheel	4 mm (Rev) 0.02 mm (Gra)	
Table feed on handwheel	7 mm (Rev) 0.05 mm (Gra)	
Table micro feed on handwheel	0.2 mm (Rev) 0.001 mm (Gra)	
Dressing handwheel	1.25 mm (Rev) 0.01 mm (Gra)	
Regulating wheel tilt angle	+5° ~ -3°	
Regulating wheel swivel angle	±5°	
Floor space (L x W x H)	1800 x 1400 x 1400 mm	
Net weight / Gross weight	1600 kgs / 1750 kgs	
Size of case (L x W x H)	2300 x 1100 x 1800 mm	

* Manufacturer reserves the right to change specification without prior notice.



JHC-12S with servo motor for regulating wheel, variable speed.



JHC-12BN

	JHC-18	JHC-18H JHC-18S	JHC-18A	JHC-18AH JHC-18AS	JHC-18B	JHC-18BH JHC-18BS
Standard work rest (dia.)	ø1~ø50 mm					
Special work rest (dia.)	ø40~ø100 mm					
Grinding wheel size (dia. x width x hole)	ø455 x 205 x ø228.6		ø455 x 255 x ø228.6		ø455 x 305 x ø228.6	
Regulating wheel size (dia. x width x hole)	ø255 x 205 x ø111.2		ø255 x 255 x ø111.2		ø255 x 305 x ø111.2	
Grinding wheel speed	1500 R.P.M					
Regulating wheel speed	13-316 R.P.M. (10 steps)	10-250 R.P.M. variable speed	13-316 R.P.M. (10 steps)	10-250 R.P.M. variable speed	13-316 R.P.M. (10 steps)	10-250 R.P.M. variable speed
Grinding wheel motor	15 HP		15 HP		20 HP	
Regulating wheel motor	2 HP	4 HP Servo Motor	2 HP	4 HP Servo Motor	3 HP	5 HP Servo Motor
Hydraulic pump motor	1 HP (+ 3 HP for H type)					
Coolant pump motor	1/4 HP		1/2 HP			
Regulating wheel feed on handwheel	3.5 mm (Rev) 0.05 mm (Gra)					
Regulating micro feed on handwheel	0.1 mm (Rev) 0.001 mm (Gra)					
Table feed on handwheel	9 mm (Rev) 0.05 mm (Gra)					
Table micro feed on handwheel	0.2 mm (Rev) 0.001 mm (Gra)					
Dressing handwheel	2 mm (Rev) 0.01 mm (Gra)					
Regulating wheel tilt angle	+5° ~ -3°					
Regulating wheel swivel angle	±5°					
Floor space (L x W x H)	2300 x 2000 x 1550 mm					
Net weight / Gross weight	2800 kgs / 3100 kgs		2900 kgs / 3200 kgs		3000 kgs / 3300 kgs	
Size of case (L x W x H)	3200 x 2200 x 1900 mm					

* Manufacturer reserves the right to change specification without prior notice.

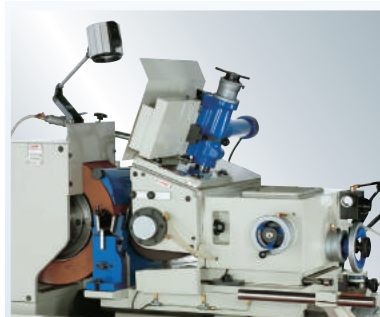

JHC-18 drive with 10 step variable speed



JHC-18A / B



JHC-18S

	JHC-20	JHC-20H JHC-20S
Standard work rest (dia.)	ø1~ø50 mm	
Special work rest (dia.)	ø40~ø100 mm	
Grinding wheel size (dia. x width x hole)	ø510 x 205 x ø254	
Regulating wheel size (dia. x width x hole)	ø305 x 205 x ø127	
Grinding wheel speed	1350 R.P.M	
Regulating wheel speed	13-316 R.P.M. (10 steps)	10-250 R.P.M. variable speed
Grinding wheel motor	20 HP	
Regulating wheel motor	3 HP	4 HP (Servo motor)
Hydraulic pump motor	1 HP (+ 3HP for H type)	
Coolant pump motor	1/2 HP	
Regulating wheel feed on handwheel	3.5 mm (Rev) / 0.05 mm (Gra)	
Regulating micro feed on handwheel	0.1 mm (Rev) / 0.001 mm (Gra)	
Table feed on handwheel	9 mm (Rev) / 0.05 mm (Gra)	
Table micro feed on handwheel	0.2 mm (Rev) / 0.001 mm (Gra)	
Dressing handwheel	2 mm (Rev) / 0.01 mm (Gra)	
Regulating wheel tilt angle	+5° ~ -3°	
Regulating wheel swivel angle	±5°	
Floor space (L x W x H)	2400 x 2000 x 1550 mm	
Net weight / Gross weight	3200 kgs / 3500 kgs	
Size of case (L x W x H)	3200 x 2200 x 1900 mm	

* Manufacturer reserves the right to change specification without prior notice.



JHC-20

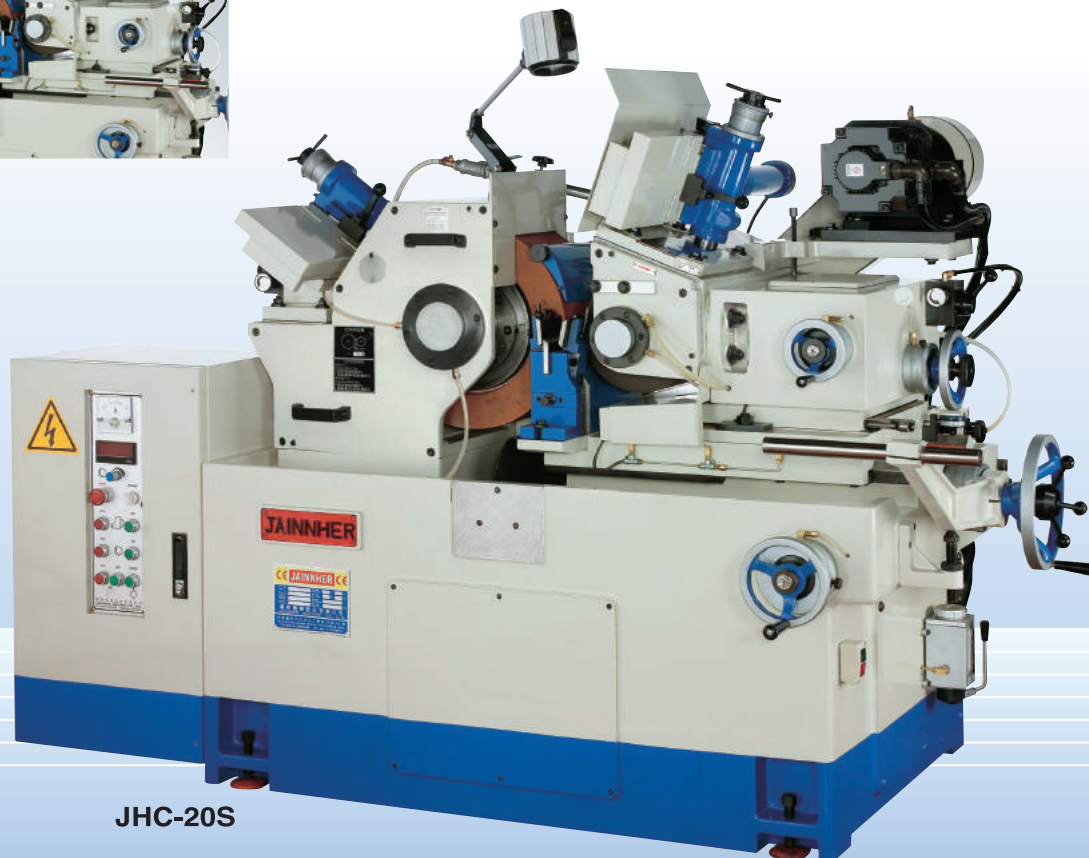

JHC-20S

	JHC-2408H	JHC-2410H	JHC-2412H
Standard work rest (dia.)	ø2~ø60 mm	ø2~ø60 mm	ø2~ø60 mm
Special work rest (dia.)	ø50~ø150 mm	ø50~ø150 mm	ø50~ø150 mm
Grinding wheel size (dia. x width x hole)	ø610 x 205 x ø304.8	ø610 x 255 x ø304.8	ø610 x 305 x ø304.8
Regulating wheel size (dia. x width x hole)	ø305 x 205 x ø127	ø305 x 255 x ø127	ø305 x 305 x ø127
Grinding wheel speed	1050 R.P.M		
Regulating wheel speed	10-250 R.P.M. variable speed		
Grinding wheel motor	25 HP	30 HP	30HP
Regulating wheel motor	4 HP Servo Motor	5 HP Servo Motor	5 HP Servo Motor
Spindle circulating pump motor	+ 3 HP		
Coolant pump motor	1/2 HP		
Regulating wheel feed on handwheel	2.5 mm (Rev) / 0.01 mm (Gra)		
Regulating micro feed on handwheel	0.02 mm (Rev) / 0.001 mm (Gra)		
Table feed on handwheel	2.5 mm (Rev) / 0.01 mm (Gra)		
Table micro feed on handwheel	0.02 mm (Rev) / 0.001 mm (Gra)		
Dressing handwheel	2 mm (Rev) / 0.01 mm (Gra)		
Regulating wheel tilt angle	+3° ~ -5°		
Regulating wheel swivel angle	±1°		
Floor space (L x W x H)	2800x2450 x 1650mm		
Net weight / Gross weight	6500 kgs / 7000 kgs		
Size of case (L x W x H)	3000 x 1800 x 1950 mm (machine), 2600 x 1400 x 1300 mm (accessory)		

* Manufacturer reserves the right to change specification without prior notice.

- The Grinding Wheel Spindle runs on hydrostatic bearings, extended tool life and increase accuracy under heavy cut loads.
- Lower Slide is equipped with a heavy bearing, precision linear motion system (slide way system) and C3 Class Ball Screw and a total length of 1,350mm.
- Upper Slide is equipped with heavy loading linear motion system and C3 Ball Screw with Fine Tuning and positioning ability up to 0.001mm.
- The machine body is designed for both conventional as well as CNC machines. Double Feed axis and Double slides design are easily accomplished with automatic and computerized Numerical Control (CNC) System. This enables it to eliminate the trouble caused by former single feed axis while CNC and automated.

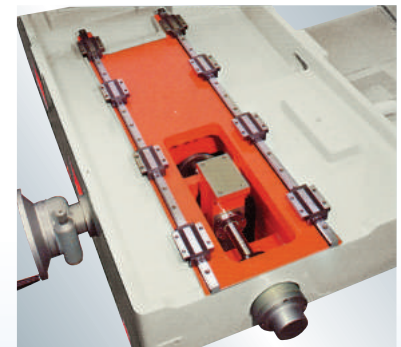

Lower Slide Way is equipped with Heavy Bearing, Linear Motion System and Ball Screws.

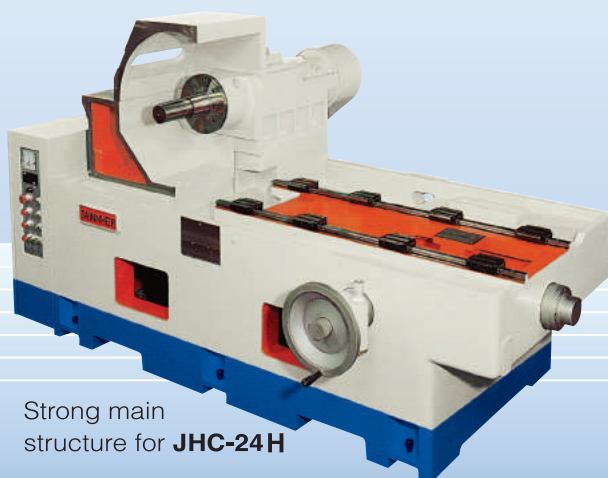

Strong main structure for **JHC-24H**



JHC-24H

	JHC-2408T-NC3	JHC-2408T-CNC6
Standard work rest (dia.)	ø2~ø230 mm	
Grinding wheel size dia. x width x hole)	ø610 x 205 x ø304.8	
Regulating wheel size dia. x width x hole)	ø305 x 205 x ø127	
Grinding wheel speed	1050 R.P.M	
Regulating wheel speed	10-250 R.P.M. variable speed	
Grinding wheel motor	40 HP	
Regulating wheel motor	5.5 KW Servo Motor	
Spindle circulating pump motor	1 HP + 3 HP	
Coolant pump motor	1/2 HP	
Grinding wheel feed	3.5 KW Servo Motor	2.5 KW Servo Motor
Grinding wheel dressing attachment	0.4 KW Servo Motor	0.5 KW Servo Motor
Regulating wheel feed	2.5 mm (Rev) 0.01 mm (Gra)	2.5 KW Servo Motor
Regulating micro feed on handwheel	0.02 mm (Rev) 0.001 mm (Gra)	----
Regulating wheel dressing attachment	2 mm (Rev) 0.01 mm (Gra)	0.5 KW Servo Motor
Grinding wheel dressing cross slide	0.75 KW Servo Motor	0.75 KW Servo Motor
Regulating wheel dressing cross slide	Hydraulic	0.75 KW Servo Motor
Regulating wheel tilt angle	+3° ~ -5°	
Regulating wheel swivel angle	±1°	
Floor space (L x W x H)	3100 x 2400 x 1950 mm	
Net weight / Gross weight	7000 kgs / 7500 kgs	
Size of case (L x W x H)	3300 x 2250 x 2150 mm (machine), 2600 x 1400 x 1300 mm (accessory)	

* Manufacturer reserves the right to change specification without prior notice.

- Machine with grinding, regulating wheels symmetry axis direction of feeding, to collocate JAINNHER's design of large loading unloading device, machine can grind maximum workpiece diameter 230mm of large bar material. Without adjust loading unloading device after grinding, regulating wheels wearing. It substantially increases in production efficiency.
- Wheel spindle runs on hydrostatic bearings, can be carried heavy load and cut. It effectively reduces the wear and keeps the spindle running in center of structure. High-precision and extended machines life of the advantages.
- This machine can be used with CNC control, the program control feeding and dressing to achieve automation functions. Improve work efficiency and product stability.
- Grinding, regulating wheels feeding axis use box way linear motion system, C1 Class Ball Screw, angular contact ball bearing and pretension nut to achieve high precision machine.



The CNC system is with servo motor & ball screws in both axes. Consistent, automatic wheels dressing, suitable for precision fine tuning. Accurate, automatic dimensional & servo feed system. Comprehensive, automatic in – process feed units. It is easy to adjust through the CNC control system.

CNC 1 AXES	Name of axis: X-axis, U-axis Worktable feed,Regulating wheel feed
CNC 2 AXES	Name of axis: X-axis, U-axis Worktable feed,Regulating wheel feed
CNC 3~4 AXES	Name of axis: X-axis, Y-axis, Z-axis, U-axis Worktable feed,Grinding wheel dressing cross slide,Grinding wheel dressing attachment,Regulating wheel feed
CNC 5~6 AXES	Name of axis: X-axis, U-axis, Z-axis, Y-axis, W-axis, V-axis Worktable feed,Grinding wheel dressing cross slide,Grinding wheel dressing attachment,Regulating wheel feed,Regulating wheel dressing cross slide,Regulating wheel dressing attachment
CNC 7~8 AXES	Name of axis: X-axis, U-axis, Z-axis, Y-axis, W-axis, V-axis, A-axis B-axis Worktable feed,Grinding wheel dressing cross slide,Grinding wheel dressing attachment,Regulating wheel feed,Regulating dressing cross slide,Regulating wheel dressing attachment Horizontal travel for robot system

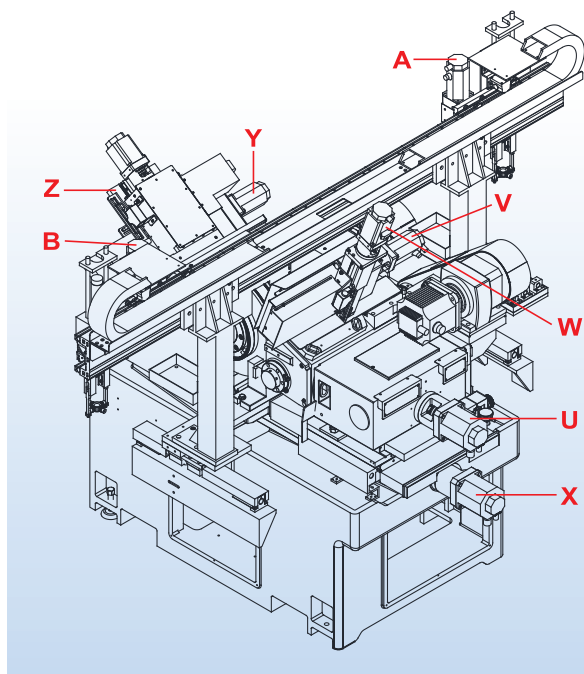

- A. Horizontal travel for robot system
- B. Horizontal travel for robot system
- U. Regulating wheel feed
- V. Regulating wheel dressing cross slide
- W. Regulating wheel dressing attachment
- X. Worktable feed
- Y. Grinding wheel dressing cross slide
- Z. Grinding wheel dressing attachment

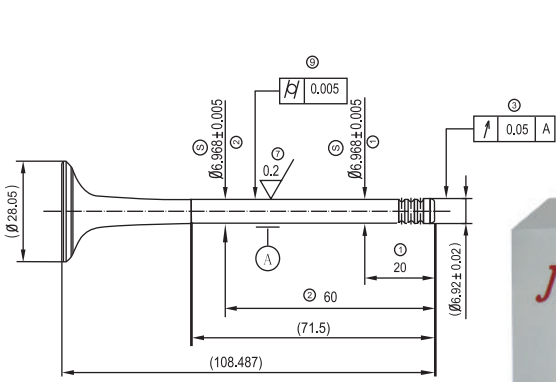

Operation Applications

JHC-18S-CNC6 Axes for grinding automobile engine valve

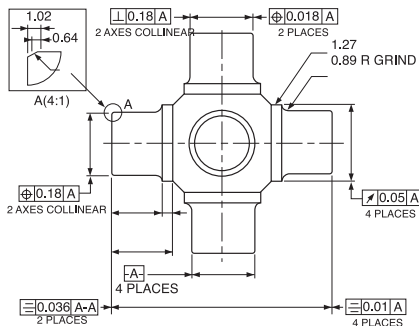

Material: SCM415H
 Hardness: HRC59~64
 Stock removal: 0.2 mm~0.3 mm
 Cycle time: 40 sec/pc



JHC-18 CNC 8 axes with robot system and relay transplanter for grinding universal joint kits. (Rotor system is for loading & unloading)



JHC-18S-NC1 Axis for grinding ejector pin



JHC-12S with small size bar feeder & receiver

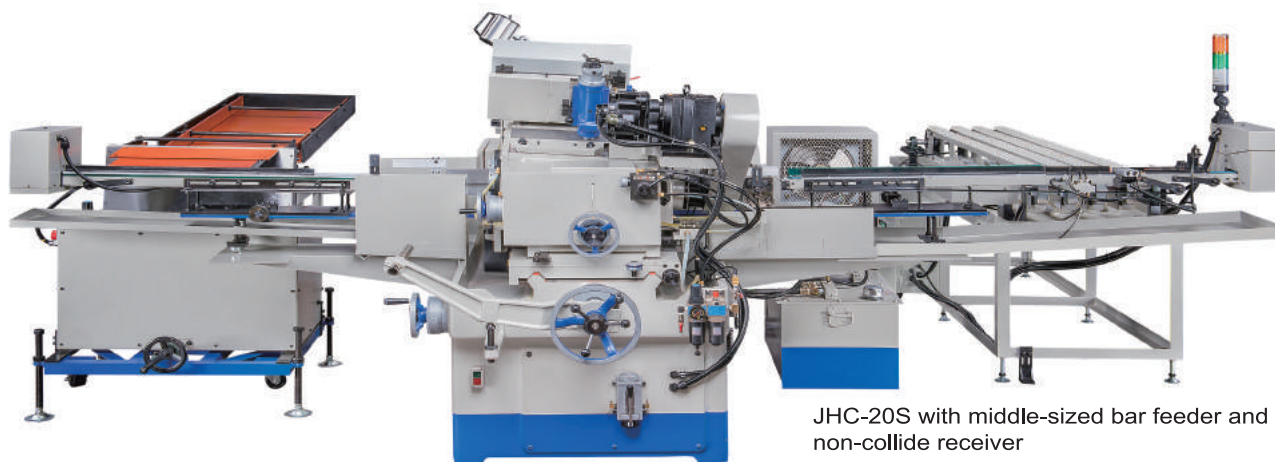

JHC-20S with middle-sized bar feeder and non-collide receiver

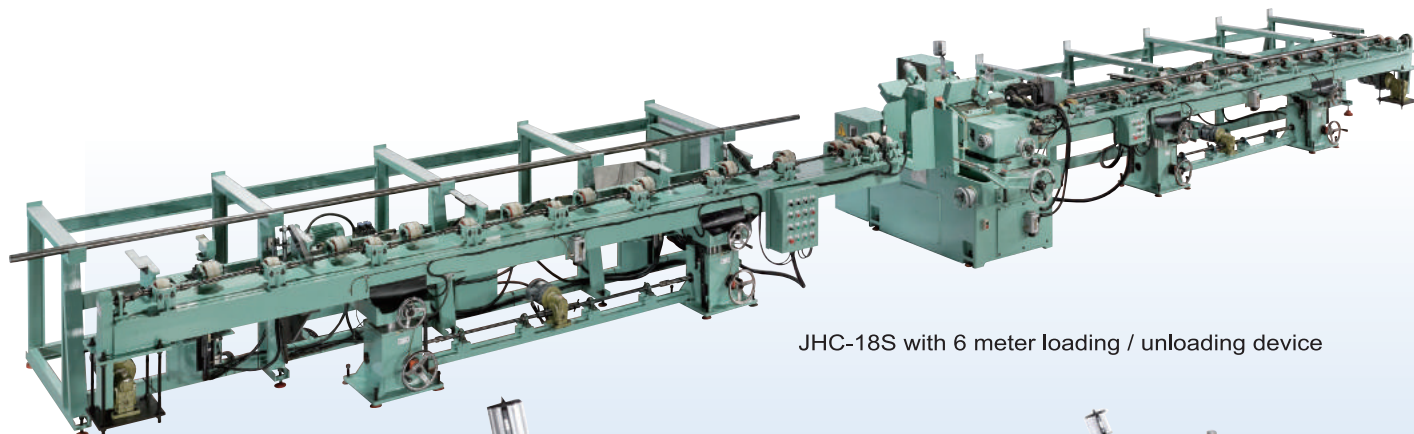

JHC-18S with 6 meter loading / unloading device

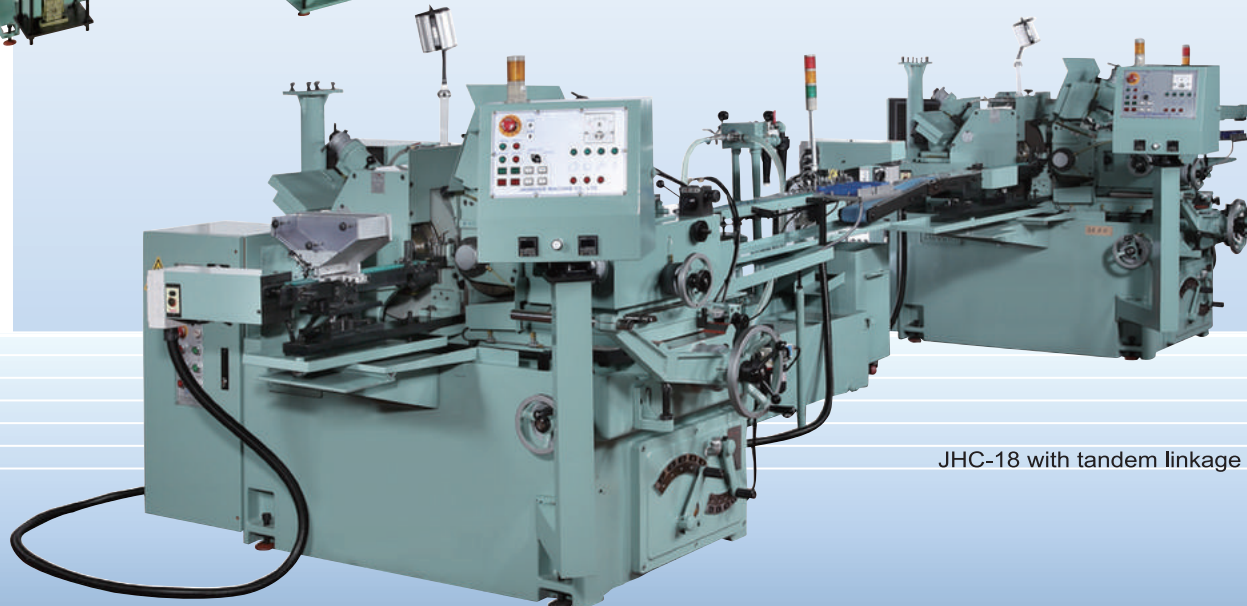

JHC-18 with tandem linkage

Standard Accessories



① Grinding wheel and grinding wheel flange
x 1 set

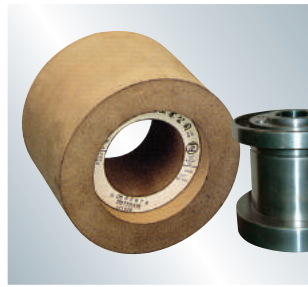

② Regulating wheel and regulating wheel flange
x 1 set

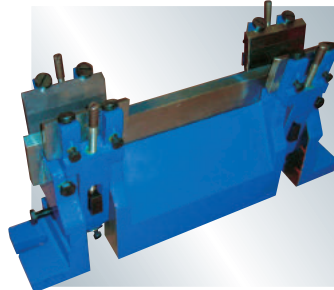

③ Thrufeed standard workrest and blade
x 1 set

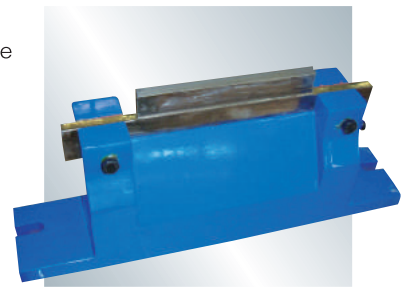

④ Infeed standard workrest and blade
x 1 set



⑤ Tool box and tools
x 1 set



⑥ Work lamp
x 1 set



⑦ Diamond tool
x 2 pcs

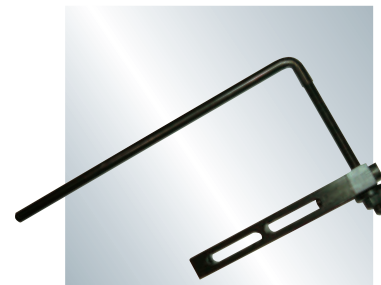

⑧ Thrufeed safety device
x 1 set

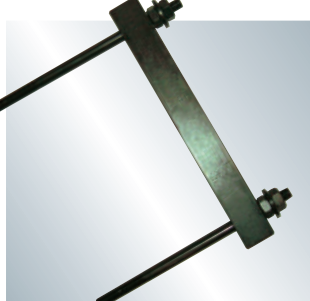

⑨ Flange extractor
x 1 set



⑩ Levelling screw and plate
x 1 set



⑪ Thrufeed process gauge
x 1 set



⑫ Coolant tank with pump (coolant tank will not be equipped with paper filter and hydrocyclone coolant filtering unit)
x 1 set



⑬ Hydraulic tank with pump
x 1 set

Optional Accessories

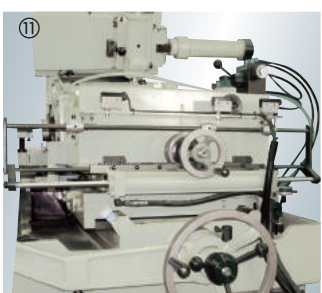
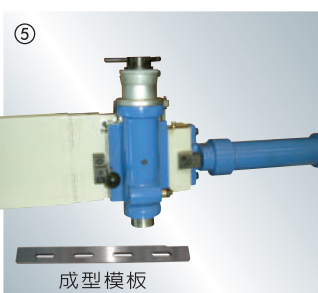
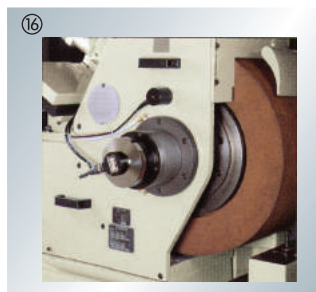
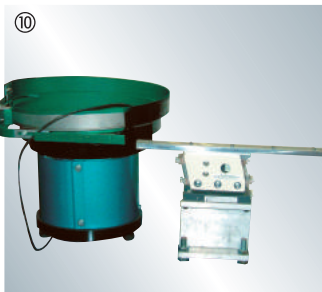
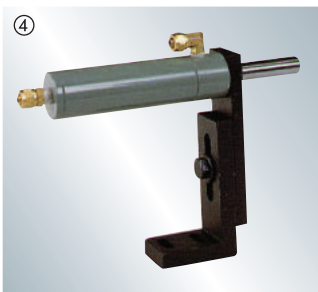
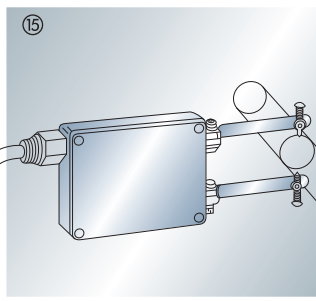
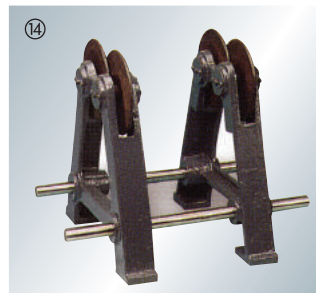
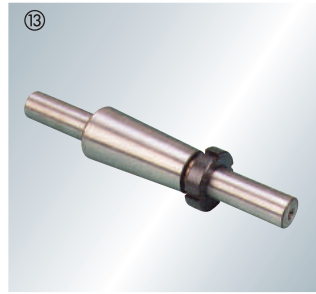
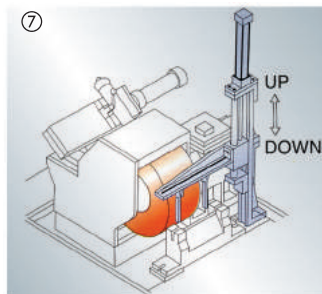

- ① Magnetic separator
- ② Paper filter coolant
- ③ Hydrocyclone coolant filtering unit
- ④ Work ejector device
- ⑤ Forming dressing device
- ⑥ Long V-shaped support
- ⑦ Manual parts feeder for infeed grinding
- ⑧ Automatic receiver for thrufeed grinding
- ⑨ Automatic thrufeed device
- ⑩ Vibratory parts feeder and straight line feeder
- ⑪ Auto thrufeed taper grinding device
- ⑫ Auto infeed forming grinding
- ⑬ Wheel balancing arbor
- ⑭ Wheel balancing base
- ⑮ Off-line gauging, non-contact O.D. measuring system
- ⑯ Grinding wheel automatic balancing system
- ⑰ Oil cooler
- ⑱ Rotary type grinding wheel dressing attachment
- ⑲ Jib crane & hook for grinding wheel
- ⑳ Grinding balancer for wheels
- ㉑ Oil mist / vapour receiver

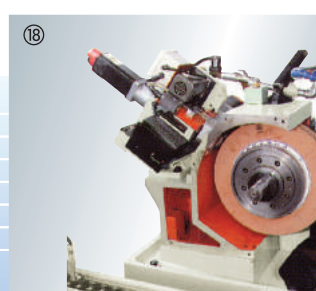
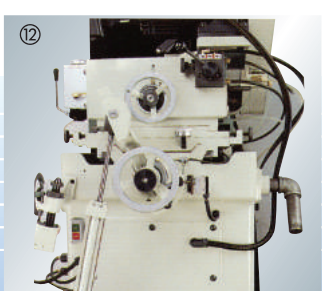

成型模板

JAINNHER®
JAINNHER MACHINE CO., LTD.

No. 333, 28th Rd., Taichung Industrial Park, Taichung, Taiwan 407

TEL: 886-4-2358-5299 FAX: 886-4-2359-4803

E-mail: saledep@jainnher.com

www.jainnher.com