

# 高精密油壓機械系列產品

## HIGH PRECISION HYDRAULIC MACHINES SERIES

- 油壓深絞成型機 YCT SERIES
- 油壓 C 型沖床 YCT-C SERIES
- 油壓四柱型沖床 YCH SERIES





# 油壓深絞成型機 YCT系列

## HYDRAULIC STRAIGHT-SIDE PRESS YCT SERIES

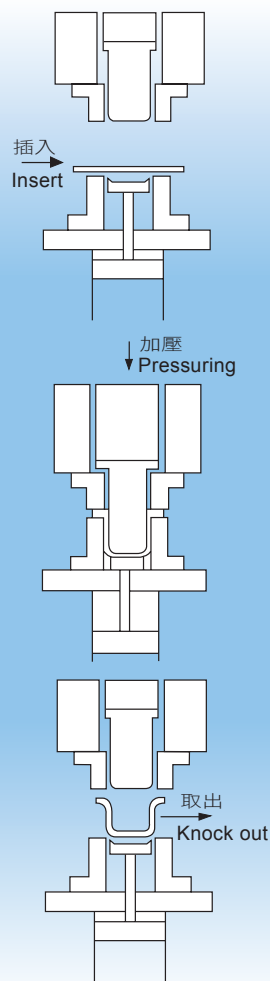

### 規格 SPECIFICATION

型式 Type (Model)	出力 Capacity (Ton)	工作台面積 Table Size (mm)	最大開距 Daylight (mm)	行程 Stroke (mm)	緩衝能力 Cushion Capacity (ton)	緩衝行程 Cushion Stroke (mm)	下降速度 Descending Speed (mm/sec)	加壓速度 Pressing Speed (mm/sec)	上昇速度 Ascending Speed (mm/sec)	電動機 Drive Motor (HP)
YCT-100	100	800X700	650	500	30	180	200-250	15-20	250	20
YCT-150	150	1000X850	800	600	50	200	200-250	15-20	250	25
YCT-200	200	1200X1000	950	700	70	250	200-250	15-20	250	30
YCT-250	250	1350X1100	1000	800	80	250	200-250	15-20	250	40
YCT-300	300	1500X1200	1100	800	100	300	200-250	10-15	250	50
YCT-400	400	1800X1300	1200	800	140	300	200-250	10-12	250	60
YCT-500	500	2000X1500	1400	1000	180	350	200-250	10-12	250	75
YCT-600	600	2000X1500	1400	1000	200	350	250	10-12	250	100
YCT-800	800	2500X1800	1500	1000	250	400	250	10-12	250	125
YCT-1000	1000	3000X2000	1800	1200	300	500	250	10-12	250	150
YCT-1200	1200	3200X2400	1800	1300	450	450	300-350	10-20	250	175
YCT-1500	1500	3600X2400	2000	1500	500	500	300-350	10-20	250	200

★本公司不斷研究改進，若規格有任何更改，恕不另行通知。 Under our continuous R&D, for any change in specifications without prior notice.

▶ 特殊附件 OPTIONAL ACCESSORIES  
快速換模系統 Quick Die Change Systems



人機介面數位系統  
Human-Machine  
Interface Controller  
System

舉模器及油壓夾具  
控制系統  
Control System  
For Die Lifter And  
Hydraulic Fixture

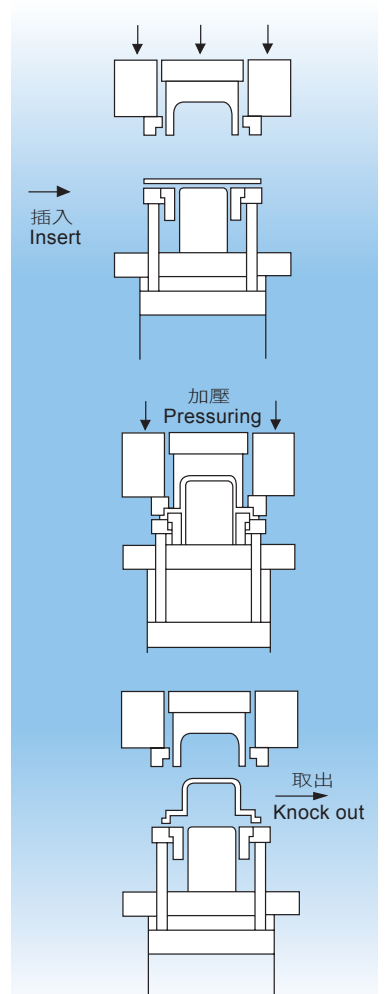

特點 FEATURES

本機專為金屬板等深抽拉引成型加工而特殊設計之高精度專用機，成型能力由100噸到2000噸均可承製。

此機型針對現今生產速度及機械之安全的要求，採用特別之迴路以達至其安全性及高速性。

- 安全、確實的控制系統，操作簡單，作業效率高。
- 油壓裝置設計使用邏輯迴路方式，防漏、防震性能特佳，外觀整潔，保養簡便。
- 嚴格的品質管制，專業化的生產，性能優越，精度確實，服務迅速。

These hydraulic press are specially designed for precision deep drawing of metal plates. Available in 100 to 2000 tons, offer high efficiency and accuracy.

Our design adopt special loop control system in order to meet the modern industrial requirement of high speed production and extremely safety.

- Safe and accurate control systems, simple operation and high efficiency.

- Special features: adopting logical hydraulic system, anti-leaking anti-vibration, beautiful appearance and easy to maintenance.
- Specializing in manufacturing hydraulic bending machines, strict quality control, integrated process to finish precision products and after-sale services.



# 油壓深絞成型機 YCT系列

**HYDRAULIC STRAIGHT-SIDE PRESS YCT SERIES**

2000噸油壓深絞成型機 YCT-2000

2000 Tons Hydraulic Straight-side Press YCT-2000



## 深絞成型成品例 **STRAIGHT-SIDE PRODUCTS EXAMPLES**

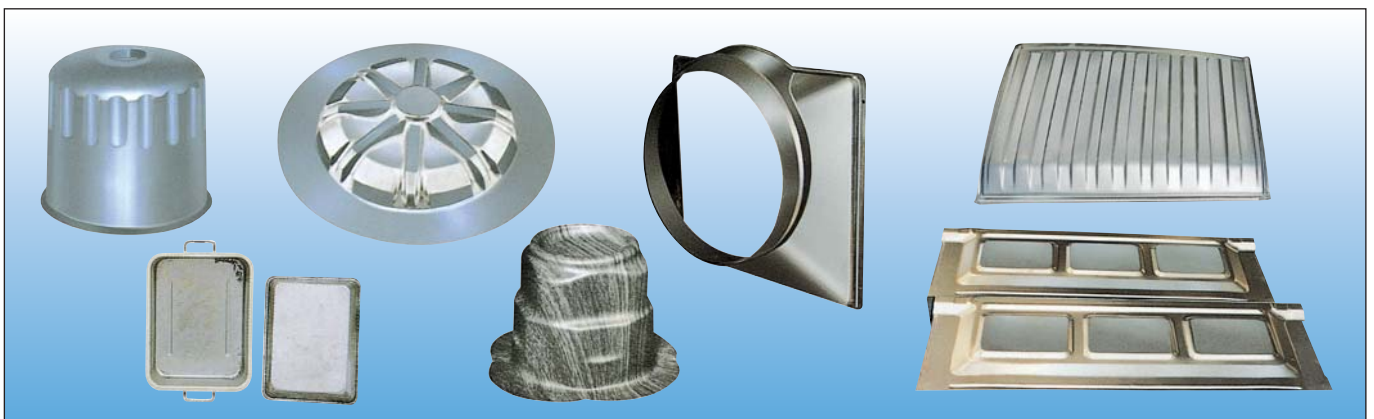

## 附件 ACCESSORIES

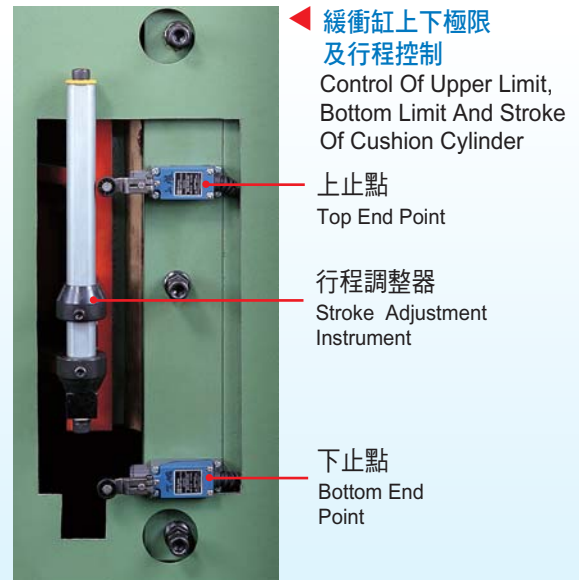
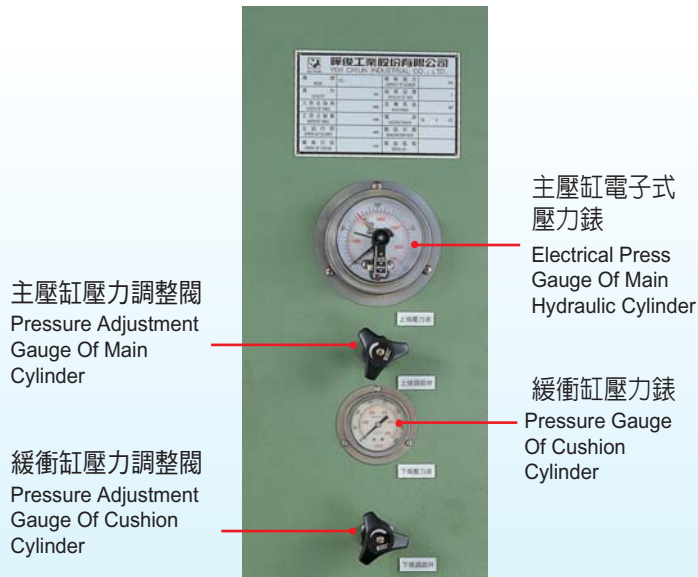

▲ 人機操作界面 (選配)  
Human-machine Interface Controller (Optional)



▲ 電機系統操作盤  
Electrical Operation Panel

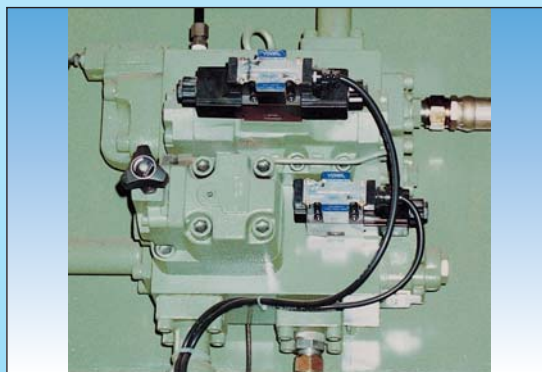

▲ 邏輯式油路板 HYDRAULIC LOGIC MANIFOLD  
油壓單元排列整潔，並以邏輯系統的油路板配管，以方便維護。  
Hydraulic unit is arranged orderly and tidily, and mated with logic systematic oil-passage plate & piping for convenient maintenance.

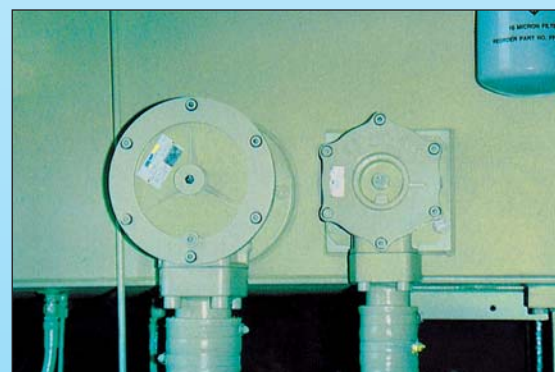

▲ 濾油網 OIL FILTER  
濾油網裝置於油箱外以方便清洗。  
Oil filter is located outside of oil tank for easy cleaning.



# 油壓C型沖床 YCT-C系列

## C-FRAME HYDRAULIC PRESS YCT-C SERIES

### YCT-C Series



#### 特點 FEATURES

- 此油壓機為 C 形狀，因所有的零件都安裝於機體內，因此機械的操作既安全又容易。
- 此機外型簡單、操作簡便。
- 此機屬於多種用途，本廠也能因應特殊需求而製成不同的特殊形狀及功能。
- The machine structure is C-frame. All the parts are including in machine body, the operation is safe and simple.
- Design is simple and free of trouble.
- The machine is multiple purpose, we are able to modify the design and enhance functions to meet your special requirements.

#### 用途 APPLICATIONS

1. 軸及套筒類之壓入及取出。
  2. 鈹金的折曲及深絞拉引。
  3. 各種材料的矯正及成型、切斷及沖孔。
  4. 適合於壓縮試驗用。
  5. 電腦機外殼及鈹金零件。
  6. O A 鋼製傢具抽屜、軌道零件。
  7. 空調冷氣機外殼零件。
  8. 建築產業機器零件製造。
1. Press in and push out of shafts and sockets.
  2. The bending and deep drawing of sheet metal.
  3. Straighten, forming, shear and punching.
  4. Compression testing.
  5. Production of computer cabinet and parts
  6. Office furniture components including drawer, rails.
  7. Cabinet and components of refrigeration and air conditioner.
  8. Architecture industrial machine components manufacture.

#### 特殊附件

全數值式控制定位系統

特點：人機介面全數值式磁力尺控制定位，  
±公差0.05mm。

#### OPTIONAL ACCESSORIES

TNC (Total Numerical Control) Positioning System

FEATURES : Human-Machine Interface

TNC (Total Numerical Control)

Magnetic Positioning ±0.05mm.

# 油壓C型沖床 YCT-CG系列

## CG-FRAME HYDRAULIC PRESS YCT-CG SERIES

YCT-C Series



YCT-CG Series



特殊附件  
OPTIONAL ACCESSORIES  
安全電眼開關  
Safety Sensor Switch

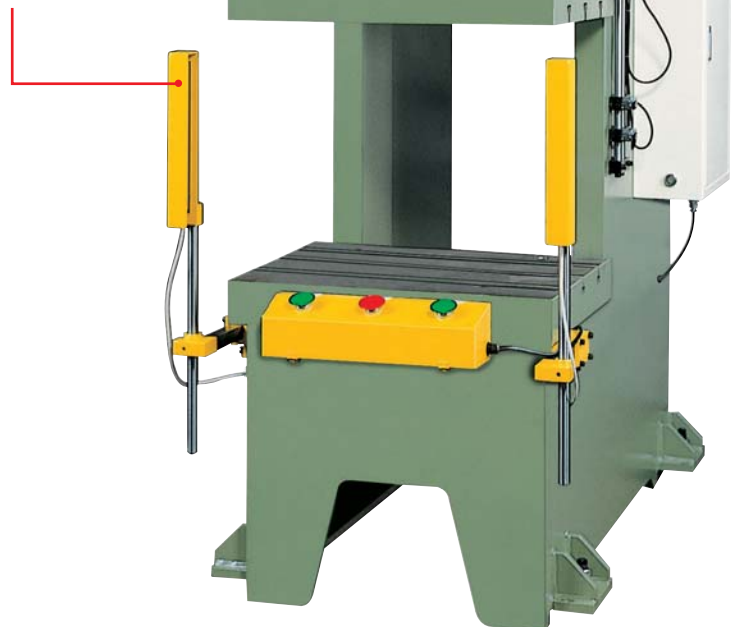

### 規格 SPECIFICATION

型式 Type (Model)	出力 Capacity (Ton)	工作台面 Table size (mm)	最大開距 Daylight (mm)	行程 Stroke (mm)	下降速度 Descending Speed (mm/sec)	加壓速度 Pressing Speed (mm/sec)	上昇速度 Ascending Speed (mm/sec)	馬達 Motor (HP)
YCT-C10	10	550X425	450	300	160	10	170	3
YCT-C20	20	600X425	450	300	160	15	160	5
YCT-C30	30	600X500	450	300	170	14	160	7.5
YCT-C50	50	700X600	500	350	180	14	180	10
YCT-C100	100	750X600	600	400	200	14	200	15
YCT-C150	150	900X700	700	450	200	14	200	20
YCT-C200	200	1000X800	700	450	200	10	200	25
YCT-C300	300	1000X800	700	450	200	10	200	30

★本公司不斷研究改進，若規格有任何更改，恕不另行通知。  
Under our continuous R&D, for any change in specifications without prior notice.

# 油壓四柱型沖床 YCH系列

## 4-POST HYDRAULIC PRESS YCH SERIES



### 特點 FEATURES

- 此油壓機為四柱型，因所有的零件都安裝於機體內，因此機械的操作既安全又容易。
- 此機外型簡單、操作簡便。
- 此機屬於多種用途，本廠也能因你的特殊需求而製成不同的特殊形狀及功能。
- The machine structure is 4-Post. All the parts are including in machine body, the operation is safe and simple.
- Design is simple and free of trouble.
- The machine is multiple purpose, we are able to modify the design and enhance functions to meet your special requirements.

### 用途 APPLICATIONS

1. 軸及套筒類之壓入及取出。
  2. 鈹金的折曲及深絞。
  3. 各種材料的矯正及成型、切斷及沖孔。
  4. 適合於壓縮試驗用。
  5. 電腦機外殼及鈹金零件。
  6. O A 鋼製傢具抽屜、軌道零件。
  7. 高科技複合材料壓合加工。
1. Press in and push out of shafts and sockets.
  2. The bending and deep drawing of sheet metal.
  3. Straighten, forming, shear and punching.
  4. Compression testing.
  5. Production of computer cabinet and parts
  6. Office furniture components including drawer, rails.
  7. High tech composite material press process.

### 規格 SPECIFICATIONS

型式 Type (Model)	出力 Capacity (Ton)	工作台面 Table size (mm)	最大開距 Daylight (mm)	行程 Stroke (mm)	下降速度 Descending Speed (mm/sec)	加壓速度 Pressing Speed (mm/sec)	上昇速度 Ascending Speed (mm/sec)	馬達 Motor (HP)
YCH-10	10	550X425	450	300	120	10	100	3
YCH-20	20	600X425	450	300	120	15	100	7.5
YCH-30	30	600X500	450	300	120	14	100	10
YCH-50	50	700X600	500	350	120	14	120	15
YCH-100	100	750X600	600	400	120	14	120	20
YCH-150	150	900X700	800	550	120	14	120	25
YCH-200	200	1000X800	800	600	120	10	120	30
YCH-300	300	1000X800	800	600	120	10	120	40

★本公司不斷研究改進，若規格有任何更改，恕不另行通知。

Under our continuous R&D, for any change in specifications without prior notice.



## 晔俊工業股份有限公司 YEH CHIUN INDUSTRIAL CO., LTD.

台灣一廠·台中市41463烏日區福泰街75號  
OFFICE1: NO.75, FU TAI ST., WURI DIST., TAICHUNG CITY  
41463, TAIWAN (R.O.C.)  
TEL: +886-4-23352579 FAX: +886-4-23352773

台灣二廠·台中市41468烏日區大明路成豐巷42之8號  
OFFICE2: NO.42-8, CHENG FENG LN., TAIMING RD., WURI DIST.,  
TAICHUNG CITY 41468, TAIWAN (R.O.C.)  
TEL: +886-4-23354705 FAX: +886-4-23352868

## 晔俊（昆山）机械有限公司

YEH CHIUN (KUN SHAN) MACHINERY CO., LTD.

TEL: +86-512-57932602 FAX: +86-512-57932797  
E-mail: yehchiun@126.com

<http://www.yehchiun.com>

E-mail: [sales@yehchiun.com](mailto:sales@yehchiun.com)

YC-Feb-2013-01-1000