

# 端銑刀 END MILLS

**MR**  
Since 1976

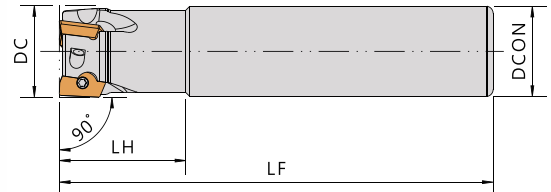

**EWEZ11-H**



with coolant 有水孔

▼ Recommended Inserts 建議刀片品牌: SUMITOMO

Order No.	Insert	Dimensions(mm)					Screw	Wrench
		刀徑 DC	柄徑 DCON	頭長 LH	長度 LF	刃數 I No.		
<b>Right / Left</b>								
EWEZ11-1416-1TL80H	AOMT11T3 AOET11T3	14	16	25	80	1	CS3006P	FT-8P
EWEZ11-1616-2TL100H		16	16	25	100	2		
EWEZ11-1612-2TL100H		16	12	25	100	2		
EWEZ11-1716-2TL100H		17	16	25	100	2		
EWEZ11-2020-2TL110H		20	20	30	110	2		
EWEZ11-2016-2TL110H		20	16	30	110	2		
EWEZ11-2020-3TL110H		20	20	30	110	3		
EWEZ11-2016-3TL110H		20	16	30	110	3		
EWEZ11-2120-3TL110H		21	20	30	110	3		
EWEZ11-2525-2TL120H		25	25	35	120	2		
EWEZ11-2525-3TL120H		25	25	35	120	3		
EWEZ11-2520-3TL120H		25	20	35	120	3		
EWEZ11-2525-4TL120H		25	25	35	120	4		
EWEZ11-2520-4TL120H		25	20	35	120	4		
EWEZ11-2520-4TL170H		25	20	35	170	4		
EWEZ11-2625-4TL120H		26	25	35	120	4		
EWEZ11-3025-4TL130H		30	25	40	130	4		
EWEZ11-3232-2TL130H		32	32	40	130	2		
EWEZ11-3232-3TL130H		32	32	40	130	3		
EWEZ11-3232-4TL130H		32	32	40	130	4		
EWEZ11-3232-5TL130H		32	32	40	130	5		
EWEZ11-3225-5TL130H		32	25	40	130	5		
EWEZ11-3532-5TL130H		35	32	40	130	5		
EWEZ11-4032-2TL150H	40	32	30	150	2			
EWEZ11-4032-4TL150H	40	32	30	150	4			
EWEZ11-4032-6TL150H	40	32	30	150	6			
EWEZ11-5032-5TL150H	50	32	30	150	5			
EWEZ11-5032-7TL150H	50	32	30	150	7			

**EWEZ11-LH**

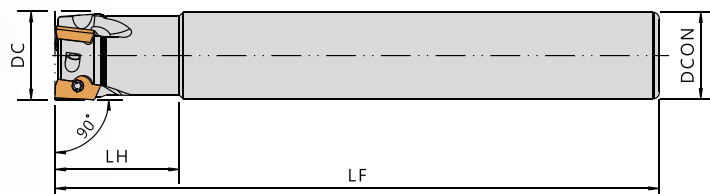

with coolant 有水孔

Recommended Inserts 建議刀片品牌: SUMITOMO

Order No.	Insert	Dimensions(mm)					Screw	Wrench
		刀徑 DC	柄徑 DCON	頭長 LH	長度 LF	刃數 I No.		
Right / Left								
EWEZ11-1416-1TL120-LH	AOMT11T3 AOET11T3	14	16	25	120	1	CS3006P	FT-8P
EWEZ11-1616-2TL145-LH		16	16	25	145	2		
EWEZ11-1614-2TL145-LH		16	14	25	145	2		
EWEZ11-1716-2TL145-LH		17	16	25	145	2		
EWEZ11-2020-2TL150-LH		20	20	40	150	2		
EWEZ11-2018-2TL150-LH		20	18	25	150	2		
EWEZ11-2120-2TL150-LH		21	20	30	150	2		
EWEZ11-2525-2TL170-LH		25	25	50	170	2		
EWEZ11-2522-2TL170-LH		25	22	30	170	2		
EWEZ11-2525-3TL170-LH		25	25	50	170	3		
EWEZ11-2625-2TL170-LH		26	25	30	170	2		
EWEZ11-3025-2TL170-LH		30	25	30	170	2		
EWEZ11-3232-2TL170-LH		32	32	60	170	2		
EWEZ11-3230-2TL170-LH		32	30	30	170	2		
EWEZ11-3232-3TL170-LH		32	32	60	170	3		
EWEZ11-3532-2TL170-LH		35	32	30	170	2		
EWEZ11-3532-3TL170-LH		35	32	30	170	3		
EWEZ11-4032-2TL170-LH		40	32	30	170	2		
EWEZ11-5032-3TL170-LH	50	32	30	170	3			

## FWEZ11-H

殼形銑刀

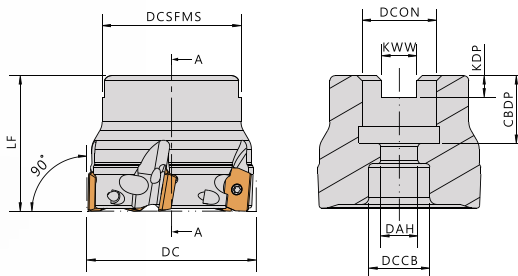

with coolant 有水孔

Recommended Inserts 建議刀片品牌: SUMITOMO

Order No.	Insert	Dimensions(mm)					Screw	Wrench
Right / Left		刀徑	長度	孔徑		刃數		
		DC	LF	DCON	DCON(inch)	I No.		
FWEZ11-D40A04H	AOMT11T3 AOET11T3	40	40	16	-	4	CS3006P	FT-8P
FWEZ11-D40A06H		40	40	16	-	6		
FWEZ11-D50A05H		50	40	22	-	5		
FWEZ11-D50A07H		50	40	22	-	7		
FWEZ11-D63A06H		63	40	22	-	6		
FWEZ11-D63A08H		63	40	22	-	8		
FWEZ11-D80A07H		80	50	27	1"	7		
FWEZ11-D80A10H		80	50	27	1"	10		
FWEZ11-D100B09H		100	50 / 63	32	1-1/4"	9		
FWEZ11-D100B12H		100	50 / 63	32	1-1/4"	12		

## WEZ11

鎖牙式端銑刀

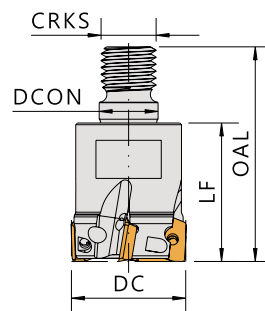

with coolant 有水孔

Recommended Inserts 建議刀片品牌: SUMITOMO

Order No.	Insert	Dimensions(mm)						Screw	Wrench
Right / Left		刀徑	柄徑	總長	長度	螺紋	刃數		
		DC	DCON	OAL	LF	CRKS	I No.		
WEZ11013M06Z1H	AOMT11T3 AOET11T3	13	6.5	39.5	25	6	1	CS3006P	FT-8P
WEZ11017M08Z2H		17	8.5	43	25	8	2		
WEZ11021M10Z2H		21	10.5	49	30	10	2		
WEZ11026M12Z3H		26	12.5	57	35	12	3		
WEZ11033M16Z4H		33	17	62	40	16	4		

EWEZ17-H

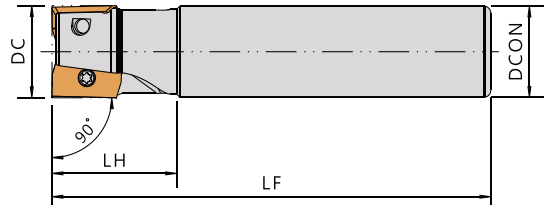

with coolant 有水孔

Recommended Inserts 建議刀片品牌: SUMITOMO

Order No.	Insert	Dimensions(mm)					Screw	Wrench
		刀徑 DC	柄徑 DCON	頭長 LH	長度 LF	刃數 I No.		
Right / Left								
EWEZ17-2525-2TL120H	AOMT1705 AOET1705	25	25	35	120	2	CS4009P	DBIT-TP15
EWEZ17-2520-2TL120H		25	20	35	120	2		
EWEZ17-2825-2TL120H		28	25	35	120	2		
EWEZ17-3025-3TL130H		30	25	40	130	3		
EWEZ17-3232-2TL130H		32	32	40	130	2		
EWEZ17-3232-3TL130H		32	32	40	130	3		
EWEZ17-3225-3TL130H		32	25	40	130	3		
EWEZ17-3532-3TL130H		35	32	40	130	3		
EWEZ17-4032-3TL135H		40	32	30	135	3		
EWEZ17-4032-4TL135H		40	32	30	135	4		
EWEZ17-5032-3TL135H		50	32	30	135	3		
EWEZ17-5042-3TL135H		50	42	30	135	3		
EWEZ17-5032-5TL135H		50	32	30	135	5		
EWEZ17-5042-5TL135H		50	42	30	135	5		
EWEZ17-6332-4TL135H		63	32	30	135	4		
EWEZ17-6342-4TL135H		63	42	30	135	4		
EWEZ17-6332-6TL135H		63	32	30	135	6		
EWEZ17-6342-6TL135H		63	42	30	135	6		
EWEZ17-8032-7TL135H	80	32	30	135	7			

**EWEZ17-LH**

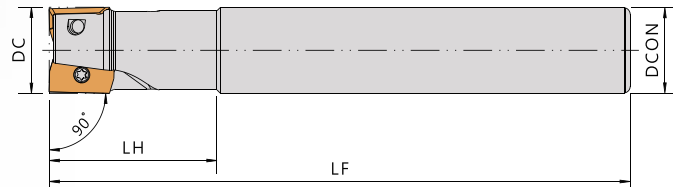

with coolant 有水孔

Recommended Inserts 建議刀片品牌: SUMITOMO

Order No.	Insert	Dimensions(mm)					Screw	Wrench
		刀徑	柄徑	頭長	長度	刃數		
Right / Left		DC	DCON	LH	LF	I No.		
EWEZ17-2525-2TL170-LH	AOMT1705 AOET1705	25	25	50	170	2	CS4009P	DBIT-TP15
EWEZ17-2825-2TL170-LH		28	25	50	170	2		
EWEZ17-3025-2TL170-LH		30	25	50	170	2		
EWEZ17-3232-2TL170-LH		32	32	60	170	2		
EWEZ17-3230-2TL170-LH		32	30	50	170	2		
EWEZ17-3232-3TL170-LH		32	32	60	170	3		
EWEZ17-3532-2TL170-LH		35	32	50	170	2		
EWEZ17-4032-2TL170-LH		40	32	50	170	2		
EWEZ17-4032-3TL170-LH		40	32	50	170	3		
EWEZ17-4032-4TL170-LH		40	32	50	170	4		
EWEZ17-5032-3TL170-LH		50	32	50	170	3		
EWEZ17-5042-3TL170-LH		50	42	50	170	3		
EWEZ17-5032-5TL170-LH		50	32	50	170	5		
EWEZ17-5042-5TL170-LH		50	42	50	170	5		
EWEZ17-6332-4TL170-LH		63	32	50	170	4		
EWEZ17-6342-4TL170-LH		63	42	50	170	4		
EWEZ17-6332-6TL170-LH		63	32	50	170	6		
EWEZ17-6342-6TL170-LH		63	42	50	170	6		

## FWEZ17-H

殼形銑刀

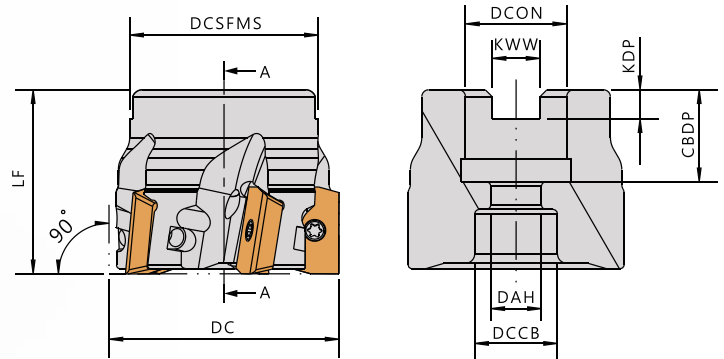

with coolant 有水孔

Recommended Inserts 刀片建議品牌: SUMITOMO

Order No.	Insert	Dimensions(mm)					Screw	Wrench
Right / Left		刀徑	長度	孔徑		刃數		
		DC	LF	DCON	DCON(inch)	I No.		
FWEZ17-D40A03H	AOMT1705 AOET1705	40	40	16	-	3	CS4009P	DBIT-TP15
FWEZ17-D40A04H		40	40	16	-	4		
FWEZ17-D50A03H		50	40	22	-	3		
FWEZ17-D50A05H		50	40	22	-	5		
FWEZ17-D63A04H		63	40	22	-	4		
FWEZ17-D63A06H		63	40	22	-	6		
FWEZ17-D80A04H		80	50	27	1"	4		
FWEZ17-D80A07H		80	50	27	1"	7		
FWEZ17-D100B05H		100	50 / 63	32	1-1/4"	5		
FWEZ17-D100B08H		100	50 / 63	32	1-1/4"	8		
FWEZ17-D125A06H		125	63	40	1-1/2"	6		
FWEZ17-D125A09H		125	63	40	1-1/2"	9		
FWEZ17-D125A11H		125	63	40	1-1/2"	11		
FWEZ17-D160C08H		160	63	40	2"	8		
FWEZ17-D160C10H		160	63	40	2"	10		
FWEZ17-D160C12H		160	63	40	2"	12		



**APX30**  
直角端銑刀

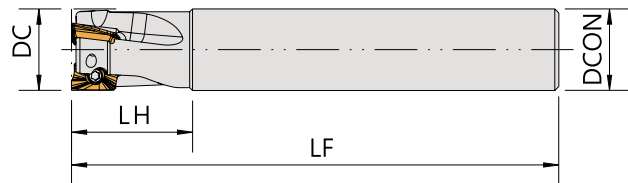

▼Recommended Inserts 建議刀片品牌: MITSUBISHI

Order No.	Insert	Dimensions(mm)					Screw	Wrench
Right / Left		刀徑 DC	柄徑 DCON	頭長 LH	長度 LF	刃數 I No.		
APX30162S16-100	AOMT1236 AOGT1236	16	16	25	100	2	CS25055	DT-8
APX30172S16-150		17	16	25	150	2		
APX30203S20-100		20	20	30	100	3	CS25065	
APX30212S20-150		21	20	30	150	2		
APX30253S25-120		25	25	35	120	3		
APX30324S32-150		32	32	45	150	4		



**BAP30  
BAP40**  
直角端銑刀

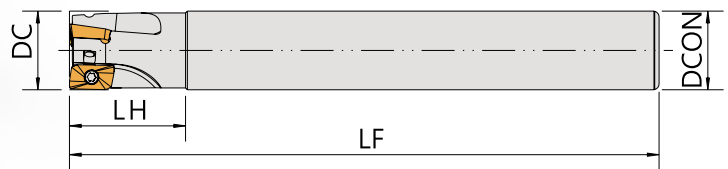
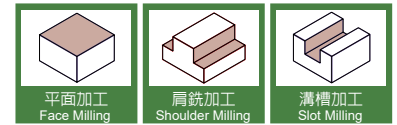

▼ Recommended Inserts 建議刀片品牌: MITSUBISHI / ACC

Order No.	Insert	Dimensions(mm)					Screw	Wrench
		刀徑 DC	長度 LF	頭長 LH	柄徑 DCON	刃數 I No.		
BAP30121S16-100	APGT1135 APMT1135	12	100	25	16	1	CS25055	DT-8
BAP30162S16-100		16	100	25	16	2		
BAP30162S16-150		16	150	25	16	2		
BAP30162S16-160		16	160	25	16	2		
BAP30172S16-150		17	150	25	16	2		
BAP30182S16-150		18	150	25	16	2		
BAP30202S20-150		20	150	30	20	2	CS25065	
BAP30203S20-100		20	100	30	20	3		
BAP30212S20-150		21	150	30	20	2		
BAP30223S20-100		22	100	30	20	3		
BAP30253S25-200		25	200	35	25	3		
BAP30254S25-120		25	120	35	25	4		
BAP30254S25-150		25	150	35	25	4		
BAP30263S25-200		26	200	35	25	3		
BAP30323S32-200		32	200	45	32	3		
BAP30325S32-150		32	150	45	32	5		
BAP30334S32-200	33	200	45	32	4			
BAP40252S25-115	APGT1604 APMT1604	25	115	35	25	2	CS40090	DBIT-T15
BAP40323S32-125		32	125	45	32	3		
BAP40404S32-125		40	125	45	32	4		

**BAP3  
BAP4**  
直角殼型銑刀

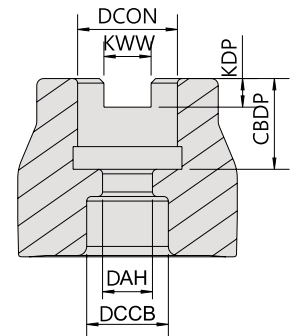
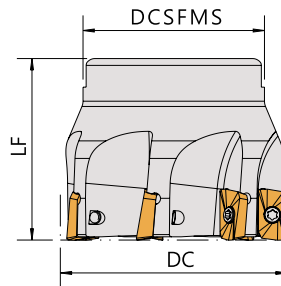
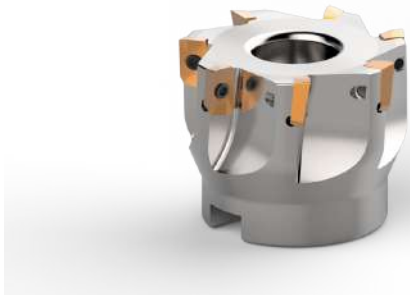
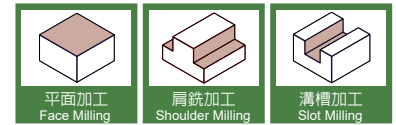

▼ Recommended Inserts 建議刀片品牌: MITSUBISHI / ACC

Standard with Coolant hole

Order No.	Insert	Dimensions(mm)					Screw	Wrench
		刀徑 DC	長度 LF	孔徑 DCON		刃數 I No.		
BAP3-05007R	APGT1135 APMT1135	50	40	22	-	7	CS25065	FT-8
BAP3-06308R		63	40	22	1"	8		
BAP3-08009R		80	50	27	1"	9		
BAP4-05005R	APGT1604 APMT1604	50	40	22	-	5	CS40090	DBIT-T15
BAP4-06306R		63	40	22	1"	6		
BAP4-08007R		80	50	27	1"	7		
BAP4-10008R		100	50	32	1-1/4"	8		
BAP4-12509R		125	50	40	1-1/2"	9		

▼ Inserts刀片:

●: Stock / ◎: 1st Choice, ○: 2nd Choice, X: Not Recommend

Tolerance Class 精度	P	鋼 Carbon Steels	◎	◎					
	M	不鏽鋼 Stainless Steels	◎	◎					
M級	K	鑄鐵 Cast Iron	◎	◎					
Specification 規格			Grade 材質		Dimensions(mm) 尺寸				
			VS203	VP15TF	L	W	T	d	r
APMT113504PDER			●	●	11	6.35	3.5	2.8	0.4
APMT113508PDER			●	●	11	6.35	3.5	2.8	0.8
APMT160408PDER			●	●	16.5	9.525	4.76	4.5	0.8

**BAP300  
BAP400**  
鎖牙式端銑刀

Modular End Mill

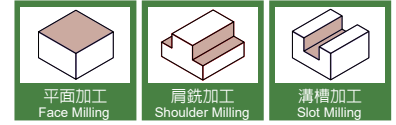
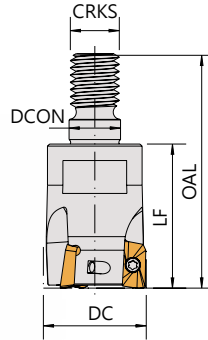

▼ Recommended Inserts 建議刀片品牌: MITSUBISHI / ACC

Order No.	Insert	Dimensions(mm)						Screw	Wrench	
Right / Left		刀徑 DC	柄徑 DCON	總長 OAL	長度 LF	螺紋 CRKS	刃數 I No.			
BAP300R111-M05	APGT1135 APMT1135	11	5.5	33.5	21	M5	1	CS25055		
BAP300R131-M06		13	6.5	37.5	23	M6	1			
BAP300R162-M08		16	8.5	43	25	M8	2			
BAP300R172-M08		17					2			
BAP300R202-M10		20	10.5	51	32	M10	2	CS25065		
BAP300R203-M10		20					3			
BAP300R212-M10		21					2			
BAP300R253-M12		25	12.5	57	35	M12	3			
BAP300R263-M12		26					3			
BAP300R324-M16		32	17	65	43	M16	4			CS40090
BAP300R334-M16		33					4			
BAP300R354-M16		35					4			
BAP400R252-M12	APGT1604 APMT1604	25	12.5	60	38	M12	2	CS40090	FT-15	
BAP400R262-M12		26					2			
BAP400R322-M16		32	17	65	43	M16	2			
BAP400R332-M16		33					2			
BAP400R352-M16		35					2			

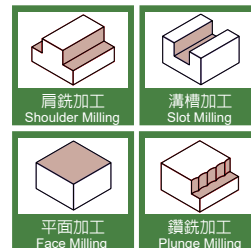
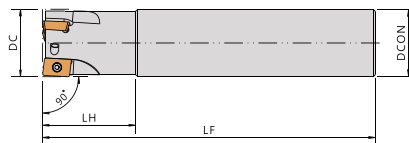

▼Recommended Inserts 建議刀片品牌: SUMITOMO / NACHI

Order No.	Insert	Dimensions(mm)					Screw	Wrench
		刀徑 DC	長度 LF	頭長 LH	柄徑 DCON	刃數 I No.		
Right / Left								
E90AP10-D10F01	APMT1035PDER	10	80	20	10	1	CS25045	DT-8
E90AP10-D10K01		10	120	30	10	1		
E90AP10-D10M01		10	150	30	10	1		
E90AP10-D10F01-12		10	80	20	12	1		
E90AP10-D12F01	APMT1035PDER	12	80	25	12	1	CS25055	
E90AP10-D12K01		12	120	25	12	1		
E90AP10-D12M01		12	150	25	12	1		
E90AP10-D14G01		14	90	25	16	1		
E90AP10-D16G02		16	90	25	16	2		
E90AP10-D16L02	APMT1035PDER	16	140	25	16	2	CS25065	
E90AP10-D16M02		16	150	25	16	2		
E90AP10-D16R02		16	200	25	16	2		
E90AP10-D18G02		18	90	25	16	2		
E90AP10-D20J02		20	110	30	20	2		
E90AP10-D20M02		20	150	30	20	2		
E90AP10-D20R02		20	200	30	20	2		
E90AP10-D21M03		21	150	30	20	3		
E90AP10-D25K03		25	120	35	25	3		
E90AP10-D25N03		25	160	35	25	3		
E90AP10-D25R03		25	200	35	25	3		
E90AP10-D30K04		30	120	35	32	4		
E90AP10-D32Q04		32	180	35	32	4		
多刃型 ( FINE PITCH )								
E90AP10-D20J03	APMT1035PDER	20	110	30	20	3	CS25065	DT-8
E90AP10-D20M03		20	150	30	20	3		
E90AP10-D25K04		25	120	35	25	4		
E90AP10-D25N04		25	160	60	25	4		
E90AP10-D26N04		26	160	35	25	4		
E90AP10-D32K05		32	120	35	32	5		
E90AP10-D32Q05		32	180	80	32	5		
E90AP10-D33Q05		33	180	35	32	5		
E90AP10-D40K06		40	125	40	32	6		
E90AP10-D40R06		40	200	100	32	6		

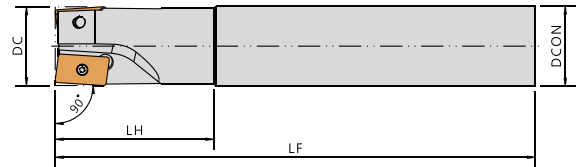
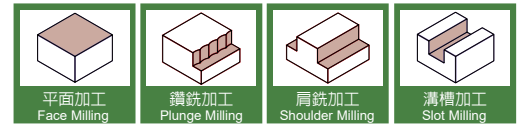

▼Recommended Inserts 建議刀片品牌: SUMITOMO / NACHI

Order No.	Insert	Dimensions(mm)					Screw	Wrench
Right / Left		刀徑	長度	頭長	柄徑	刃數		
		DC	LF	LH	DCON	I No.		
E90AP16-D25K02	APMT1605PDER	25	125	35	25	2	CS35090	DBIT-T15
E90AP16-D25N02		25	160	35	25	2		
E90AP16-D25R02		25	200	35	25	2		
E90AP16-D25S02		25	250	35	25	2		
E90AP16-D26N02		26	160	35	25	2		
E90AP16-D32K03		32	125	40	32	3		
E90AP16-D32Q03		32	180	60	32	3		
E90AP16-D35K03		35	125	40	32	3		
E90AP16-D40K04		40	125	45	32	4		
E90AP16-D40M04		40	150	45	32	4		
E90AP16-D40R04		40	200	45	32	4		
E90AP16-D50K05		50	125	40	32	5		
E90AP16-D63K06		63	125	40	32	4		

## EM90AP

### 粗銑刀

HELICAL END MILLS

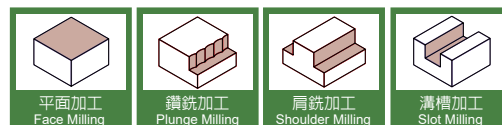
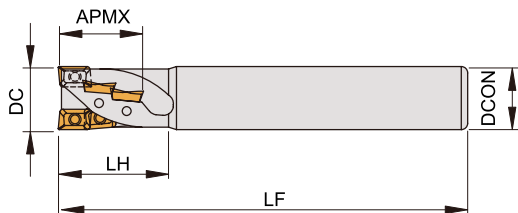

▼Recommended Inserts 建議刀片品牌: SUMITOMO / NACHI

Order No.	Insert	Dimensions(mm)							Screw	Wrench
		刀徑 DC	長度 LF	頭長 LH	柄徑 DCON	切削刃長 APMX	有效刃數 T No.	刃數 I No.		
EM90AP10-D20K06	APMT1035PDER	20	125	35	20	23	2	6	CS25065	DT-8
EM90AP10-D25K08		25	125	45	25	36	2	8		
EM90AP10-D32L15		32	140	55	32	44	3	15		
EM90AP10-D40M18		40	150	65	32	54	3	18		
EM90AP10-D40M21		40	150	73	32	62	3	21		
EM90AP16-D40M12	APMT1605PDER	40	150	65	42	51	3	12	CS35090	DBIT-T15
EM90AP16-D40R21		40	200	99	42	80	3	21		
EM90AP16-D50N15		50	165	75	42	59	3	15		

## DM90AP

### 鑽銑刀

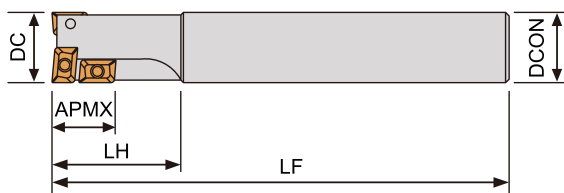

▼Recommended Inserts 建議刀片品牌: SUMITOMO / NACHI

Order No.	Insert	Dimensions(mm)							Screw	Wrench
		刀徑 DC	長度 LF	頭長 LH	柄徑 DCON	切削刃長 APMX	刃數 I No.			
DM90AP10-D20K03	APMT1035PDER	20	125	16	20	35	3	CS25065	DT-8	
DM90AP10-D20Q03		20	185	16	20	35	3			
DM90AP10-D21K03		21	125	16	20	35	3			
DM90AP10-D25L04		25	140	24	25	35	4			
DM90AP10-D25R04		25	220	24	25	35	4			
DM90AP10-D26L04		26	140	24	25	35	4			
DM90AP10-D30M05		30	150	32	25	50	5			
DM90AP16-D32M04	APMT1605PDER	32	150	40	32	50	4	CS35090	DBIT-T15	
DM90AP16-D32S04		32	230	40	32	60	4			
DM90AP16-D33M04		33	150	40	32	50	4			
DM90AP16-D40N04		40	160	40	32	60	4			
DM90AP16-D40S04		40	240	40	32	60	4			

## E90APK10

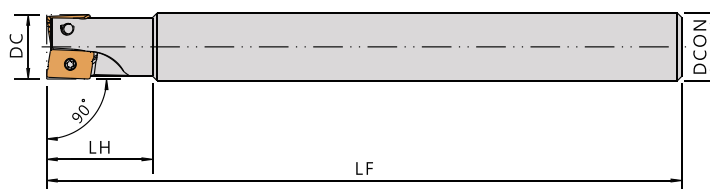
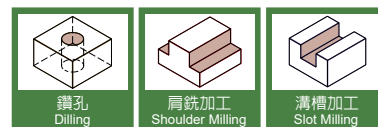

▼Recommended Inserts 建議刀片品牌: CERATIZIT

Order No.	Insert	Dimensions(mm)					Screw	Wrench
		刀徑 DC	長度 LF	頭長 LH	柄徑 DCON	刃數 I No.		
E90APK10-D10F01-12	APKT1003	10	80	20	12	1	CS25045	DT-8
E90APK10-D10K01-12		10	125	20	12	1		
E90APK10-D10M01-12		10	150	20	12	1		
E90APK10-D12F01	APKT1003	12	80	25	12	1	CS25055	
E90APK10-D12M01		12	150	25	12	1		
E90APK10-D16G02		16	90	25	16	2		
E90APK10-D16M02		16	150	25	16	2		
E90APK10-D16R02	APKT1003	16	200	25	16	2	CS25065	
E90APK10-D20J02		20	110	25	20	2		
E90APK10-D20M02		20	150	25	20	2		
E90APK10-D20R02		20	200	25	20	2		
E90APK10-D25M03		25	150	30	25	3		
E90APK10-D25R03	25	200	30	25	3			

## E90APK16

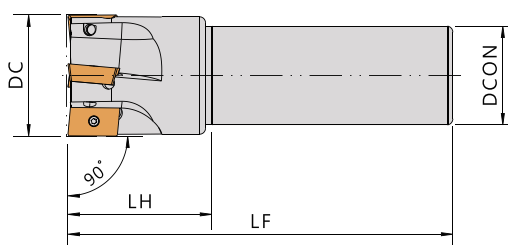

▼Recommended Inserts 建議刀片品牌: CERATIZIT

Order No.	Insert	Dimensions(mm)					Screw	Wrench
		刀徑 DC	長度 LF	頭長 LH	柄徑 DCON	刃數 I No.		
E90APK16-D25M02	APKT1604	25	150	30	25	2	CS35090	DBIT-T15
E90APK16-D25R02		25	200	30	25	2		
E90APK16-D32Q03		32	180	40	32	3		
E90APK16-D40R04		40	200	45	32	4		



## MSAP10

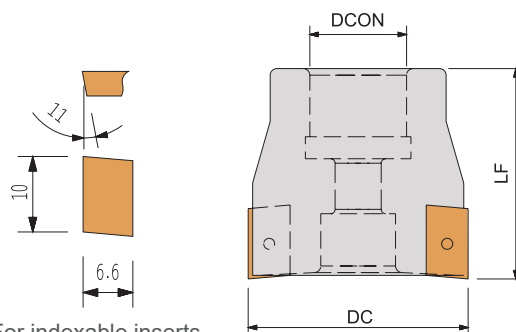
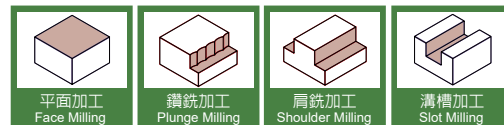

For indexable inserts  
APMT1035

▼Recommended Inserts 建議刀片品牌: SUMITOMO / NACHI

Order No.	Insert	Dimensions(mm)					Screw	Wrench
		刀徑 DC	長度 LF	孔徑 DCON		刃數 I No.		
MSAP10-D040A06R	APMT1035PDER	40	40	16	-	6	CS25065	FT-8
MSAP10-D050A07R		50	40	22	-	7		
MSAP10-D063A09R		63	46	22	1"	9		

## MSAP16

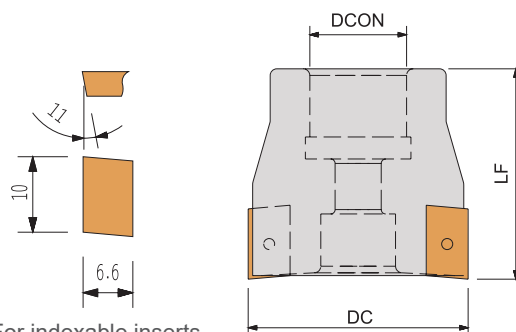
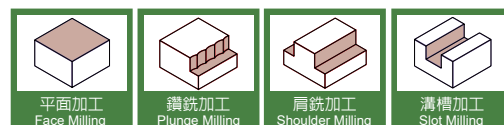

For indexable inserts  
APMT1035

▼Recommended Inserts 建議刀片品牌: SUMITOMO / NACHI

Order No.	Insert	Dimensions(mm)					Screw	Wrench
		刀徑 DC	長度 LF	孔徑 DCON		刃數 I No.		
MSAP16-D050A05R	APMT1605PDER	50	40	22	-	5	CS35090	DBIT-T15
MSAP16-D063A06R		63	46	22	1"	6		
MSAP16-D080B08R		80	46	27	1"	8		
MSAP16-D100B10R		100	50	32	1-1/4"	10		

**E90AX12**  
**E90AX12-L**

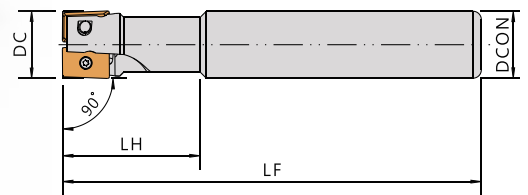
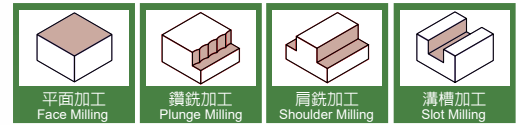

▼Recommended Inserts 建議刀片品牌: SUMITOMO / NACHI

Order No.	Insert	Dimensions(mm)					Screw	Wrench
		刀徑	長度	頭長	柄徑	刃數		
Right / Left		DC	LF	LH	DCON	I No.		
E90AX12-D14	AXMT 1235	14	80	25	16	1	CS30051H / CS30055PS	DT-8
E90AX12-D14-160		14	160	25	16	1		
E90AX12-D15		15	100	25	16	2		
E90AX12-D16		16	100	25	16	2		
E90AX12-D16-150		16	150	25	16	2		
E90AX12-D16-200		16	200	25	16	2		
E90AX12-D17-150		17	150	25	16	2		
E90AX12-D17-200		17	200	25	16	2		
E90AX12-D18		18	100	25	16	2		
E90AX12-D19		19	100	25	16	2		
E90AX12-D20-02		20	110	30	20	2		
E90AX12-D20		20	110	30	20	3		
E90AX12-D20-150		20	150	30	20	3		
E90AX12-D20-200		20	200	30	20	3		
E90AX12-D21-150		21	150	30	20	3		
E90AX12-D21-200		21	200	30	20	3		
E90AX12-D22		22	110	30	20	3		
E90AX12-D22-150		22	150	30	20	3		
E90AX12-D22-200		22	200	30	20	3		
E90AX12-D25-03		25	120	35	25	3		
E90AX12-D25		25	120	35	25	4		
E90AX12-D25-150		25	150	35	25	4		
E90AX12-D25-200		25	200	35	25	4		
E90AX12-D26-150		26	150	35	25	4		
E90AX12-D26-200		26	200	35	25	4		
E90AX12-D28		28	120	35	25	4		
E90AX12-D30		30	120	35	25	4		
E90AX12-D32		32	130	40	32	5		
E90AX12-D33-200		33	200	40	32	5		
E90AX12-D40		40	150	30	32	6		

E90AX12-D16 without cooling channel 無油孔 E90AX12-D16H with cooling channel 含油孔  
E90AX12-D16LH with longer shank and cooling channel 加長型含油孔

E90AX12-H  
E90AX12-LH

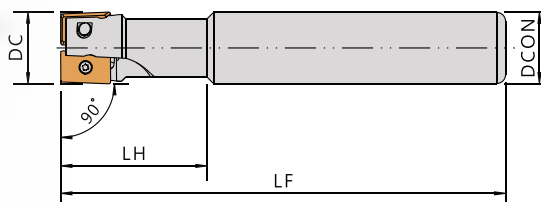
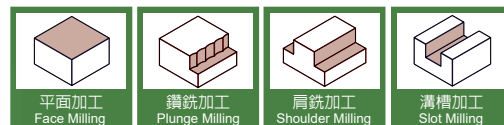

▼ Recommended Inserts 建議刀片品牌: SUMITOMO / NACHI

Order No.	Insert	Dimensions(mm)					Screw	Wrench
		刀徑 DC	長度 LF	頭長 LH	柄徑 DCON	刃數 I No.		
Right / Left								
E90AX12-D14H	AXMT 1235	14	80	25	16	1	CS30051	DT-8
E90AX12-D16H		16	100	25	16	2		
E90AX12-D18H		18	100	25	16	2	CS30051H / CS30055PS	
E90AX12-D20H		20	110	30	20	3		
E90AX12-D22H		22	110	30	20	3		
E90AX12-D25H		25	120	35	25	4		
E90AX12-D28H		28	120	35	25	4		
E90AX12-D30H		30	120	35	25	4		
E90AX12-D32H		32	130	40	32	5		
E90AX12-D40H		40	150	30	32	6		

Order No.	Insert	Dimensions(mm)					Screw	Wrench
		刀徑 DC	長度 LF	頭長 LH	柄徑 DCON	刃數 I No.		
Right / Left								
E90AX12-D14LH	AXMT 1235	14	120	25	16	1	CS30051	DT-8
E90AX12-D16LH		16	145	25	16	2		
E90AX12-D18LH		18	145	25	16	2	CS30051H / CS30055PS	
E90AX12-D20LH		20	150	40	20	2		
E90AX12-D20LH-03		20	150	40	20	3		
E90AX12-D21LH-03		21	150	40	20	3		
E90AX12-D22LH		22	150	30	20	2		
E90AX12-D25LH		25	170	50	25	2		
E90AX12-D25LH-04		25	170	50	25	4		
E90AX12-D28LH		28	170	30	25	2		
E90AX12-D30LH		30	170	30	25	2		
E90AX12-D32LH		32	180	60	32	2		
E90AX12-D40LH		40	180	30	32	2		

E90AX12-D16 without cooling channel 無油孔

E90AX12-D16H with cooling channel 含油孔

E90AX12-D16LH with longer shank and cooling channel 加長型含油孔

**E90AX17-H**  
**E90AX17-LH**

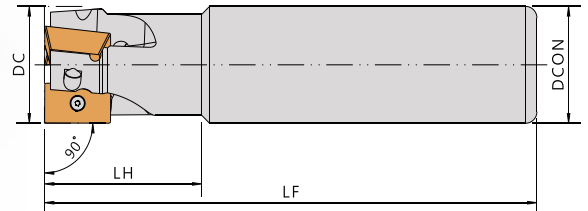
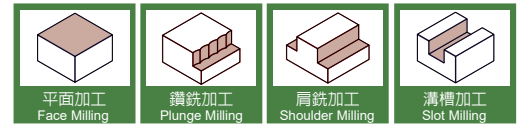

▼ Recommended Inserts 建議刀片品牌: SUMITOMO / NACHI

Order No.	Insert	Dimensions(mm)					Screw	Wrench
		刀徑 DC	長度 LF	頭長 LH	柄徑 DCON	刃數 I No.		
E90AX17-D25H	AXMT 1705	25	120	35	25	2	CS4009P	DBIT-TP15
E90AX17-D25H-20		25	120	35	20	2		
E90AX17-D28H		28	120	35	25	2		
E90AX17-D30H		30	130	40	25	3		
E90AX17-D30H-32		30	130	40	32	3		
E90AX17-D32H		32	130	40	32	3		
E90AX17-D32H-02		32	130	40	32	2		
E90AX17-D32H-25		32	130	40	25	3		
E90AX17-D35H		35	130	40	32	3		
E90AX17-D40H		40	170	50	32	4		
E90AX17-D50H		50	170	50	32	5		
E90AX17-D63H		63	170	50	32	6		
E90AX17-D63H-04		63	170	50	32	4		

Order No.	Insert	Dimensions(mm)					Screw	Wrench
		刀徑 DC	長度 LF	頭長 LH	柄徑 DCON	刃數 I No.		
E90AX17-D25LH	AXMT 1705	25	170	50	25	2	CS4009P	DBIT-TP15
E90AX17-D28LH		28	170	50	25	2		
E90AX17-D30LH		30	180	60	25	2		
E90AX17-D32LH		32	180	60	32	2		
E90AX17-D32LH-03		32	180	60	32	3		
E90AX17-D35LH		35	180	60	32	2		
E90AX17-D40LH		40	220	80	32	2		

E90AX17-D25 without cooling channel 無油孔

E90AX17-D25H with cooling channel 含油孔

E90AX17-D25LH with longer shank and cooling channel 加長型含油孔

**E90AX06**

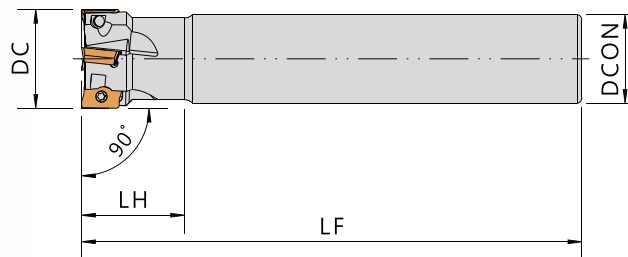
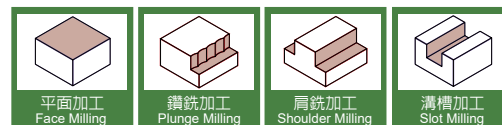

▼ Recommended Inserts 建議刀片品牌: SUMITOMO

Order No.	Insert	Dimensions(mm)					Screw	Wrench
		刀徑 DC	長度 LF	頭長 LH	柄徑 DCON	刃數 I No.		
<b>Right / Left</b>								
E90AX06-D10	AXMT0602	10	80	15	10	2	CS18040	FT-6
E90AX06-D12		12	80	20	12	3		
E90AX06-D14		14	80	20	12	3		
E90AX06-D16		16	90	20	16	4		
E90AX06-D18		18	90	20	16	4		
E90AX06-D20		20	100	25	20	5		
E90AX06-D10-L130	AXMT0602	10	130	15	10	2	CS18040	FT-6
E90AX06-D11-L150		11	150	15	10	2		
E90AX06-D12-L130		12	130	20	12	3		
E90AX06-D13-L150		13	150	20	12	3		
E90AX06-D16-L150		16	150	20	16	4		
E90AX06-D17-L150		17	150	20	16	4		

E90AX06-D16 without cooling channel 無油孔

E90AX06-D16H with cooling channel 含油孔

E90AX06-D16LH with longer shank and cooling channel 加長型含油孔

## EM90AX

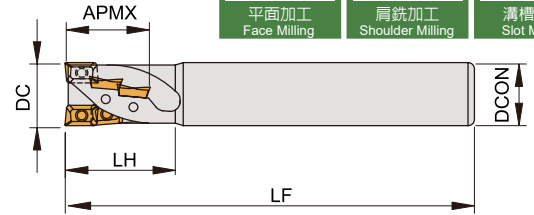

▼Recommended Inserts 建議刀片品牌: SUMITOMO / NACHI

Order No.	Insert	Dimensions(mm)							Screw	Wrench
		刀徑	長度	頭長	柄徑	切削刃長	有效刃數	刃數		
Right / Left		DC	LF	LH	DCON	APMX	T No.	I No.		
EM90AX12-D20X	AXMT 1235	20	130	45	20	27	2	6	CS30051H / CS30055PS	DT-8
EM90AX12-D25		25	130	45	25	27	2	6		
EM90AX12-D32		32	130	45	32	27	3	9		
EM90AX12-D40		40	130	45	32	36	4	16		
EM90AX12-D20L	AXMT 1235	20	130	45	20	36	1	4	CS30051H / CS30055PS	DT-8
EM90AX12-D20LX		20	130	45	20	36	2	8		
EM90AX12-D25L		25	130	45	25	36	2	8		
EM90AX12-D32L		32	150	65	32	45	3	15		

Order No.	Insert	Dimensions(mm)							Screw	Wrench
		刀徑	長度	頭長	柄徑	切削刃長	有效刃數	刃數		
Right / Left		DC	LF	LH	DCON	APMX	T No.	I No.		
EM90AX17-D32	AXMT 1705	32	150	65	32	40	2	6	CS4009P	DBIT-TP15
EM90AX17-D40		40	150	65	42	40	3	9		
EM90AX17-D50		50	165	75	42	53	3	12		

## EM90AX-S

殼型銑刀

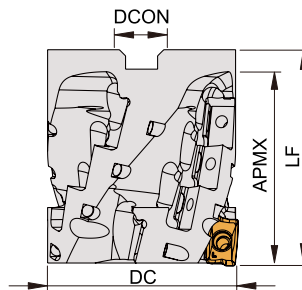

▼Recommended Inserts 建議刀片品牌: SUMITOMO / NACHI

Order No.	Insert	Dimensions(mm)							Screw	Wrench
		刀徑	孔徑		切削刃長	長度	有效刃數	刃數		
Right / Left		DC	DCON	DCON(inch)	APMX	LF	T No.	I No.		
EM90AX17-D50S	AXMT 1705	50	22	-	53	70	3	12	CS4009P	DBIT-TP15
EM90AX17-D63S		63	27	1"	53	70	4	16		
EM90AX17-D63SL		63	-	1"	68	98	4	20		
EM90AX17-D75SL		75	-	1-1/4"	80	111	4	24		
EM90AX17-D80S		80	32	-	53	85	5	20		
EM90AX17-D100S		100	40	-	53	85	6	24		

## MSAX 殼型銑刀

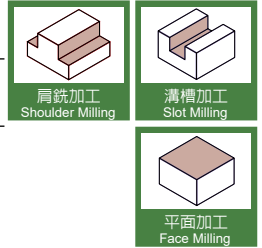
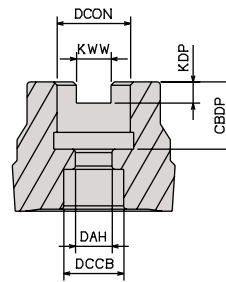
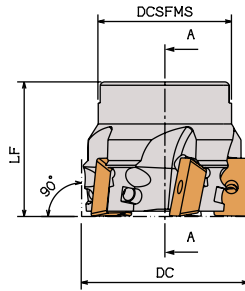

▼ Recommended Inserts 建議刀片品牌 SUMITOMO / NACHI

Order No.	Insert	Dimensions(mm)					Screw	Wrench
		刀徑 DC	長度 LF	孔徑 DCON		刃數 I No.		
MSAX12-D040A06	AXMT 1235	40	40	16	-	6	CS30051H/ CS30055PS	FT-8
MSAX12-D050A07		50	40	22	-	7		
MSAX12-D063A08		63	40	22	1"	8		

MSAX12-D040A06H x16 with coolant 有水孔

▼ Standard Pitch Type

Order No.	Insert	Dimensions(mm)					Screw	Wrench
		刀徑 DC	長度 LF	孔徑 DCON		刃數 I No.		
MSAX17-D040A04	AXMT 1705	40	40	16	-	4	CS4009P	DBIT-TP15
MSAX17-D050A05		50	40	22	-	5		
MSAX17-D063A06		63	50	22	1"	6		
MSAX17-D080A07		80	50	27	1"	7		
MSAX17-D100B08		100	63	32	1-1/4"	8		
MSAX17-D125B09		125	63	40	1-1/2"	9		

MSAX17-D040A06H x16 with coolant 有水孔

## M75AX 殼型銑刀

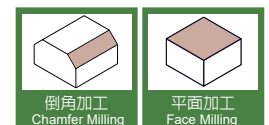
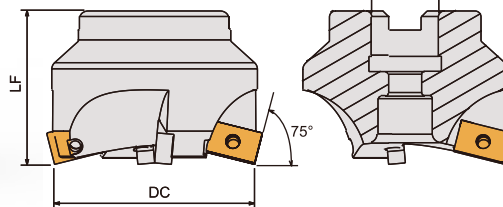

▼ Recommended Inserts 建議刀片品牌: SUMITOMO / NACHI

Order No.	Insert	Dimensions(mm)				Screw	Wrench
		刀徑 DC	長度 LF	孔徑 DCON	刃數 I No.		
M75AX17-D063A04 x22	AXMT 1705	63	50	22	4	CS4009P	DBIT-TP15
M75AX17-D080B05 x27		80	50	27	5		
M75AX17-D100B06 x32		100	63	32	6		
M75AX17-D125B07 x40		125	63	40	7		



## TEBL

高進給端銑刀

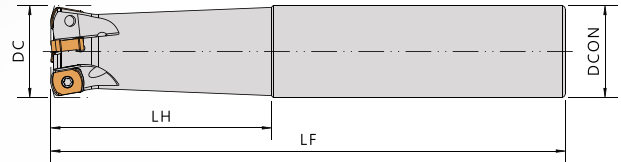

with coolant 有水孔

Recommended Inserts 建議刀片品牌: Taegutec

Order No.	Insert	Dimensions(mm)					Insert Screw	Wrench
Right / Left		刀徑	孔徑	頭長	長度	刃數		
		DC	DCON	LH	LF	I No.		
TEBL216-16-06-L120H	BLMP0603R	16	16	40	120	2	CS2508PS	FT-8P
TEBL320-20-06-L130H		20	20	50	130	3		
TEBL425-25-06-L140H		25	25	60	140	4		
TEBL532-32-06-L150H		32	32	70	150	5		

## TEBL

鎖牙式端銑刀

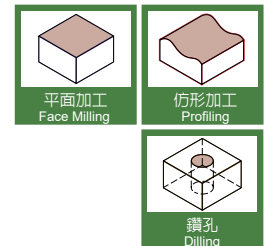
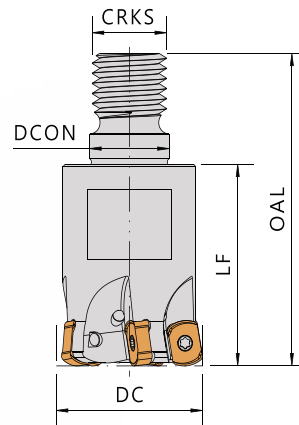

with coolant 有水孔

Recommended Inserts 建議刀片品牌: Taegutec

Order No.	Insert	Dimensions(mm)						Insert Screw	Wrench
Right / Left		刀徑	柄徑	總長	長度	螺紋	刃數		
		DC	DCON	OAL	LF	CRKS	I No.		
TEBL216-M08-06H	BLMP0603R	16	8.5	43	25	8	2	CS2508PS	FT-8P
TEBL320-M10-06H		20	10.5	49	30	10	3		
TEBL425-M12-06H		25	12.5	57	35	12	4		
TEBL532-M16-06H		32	17	62	40	16	5		
TEBL535-M16-06H		35	17	62	40	16	5		
TEBL640-M16-06H		40	17	62	40	16	6		
TEBL642-M16-06H		42	17	62	40	16	6		

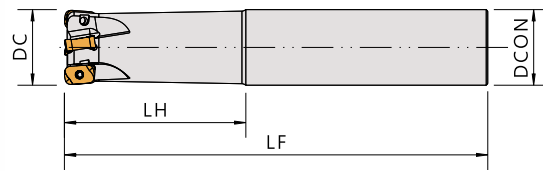
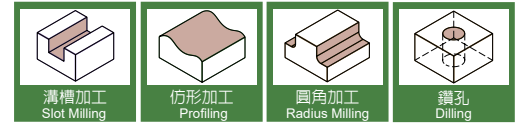

▼Recommended Inserts 建議刀片品牌: HITACHI

Order No.	Insert						Screw	Wrench
Right / Left		刀徑	柄徑	長度	頭長	刃數		
		DC	DCON	LF	LH	I No.		
ETD4N1616-2TL100	ENMU0603ER-C ENMU0603ER-B	16	16	100	30	2	CS25065	FT-8
ETD4N1616-2TL150		16	16	150	50	2		
ETD4N1716-2TL150		17	16	150	30	2		
ETD4N2020-3TL130		20	20	130	50	3		
ETD4N2020-3TL160		20	20	160	80	3		
ETD4N2120-3TL150		21	20	150	30	3		
ETD4N2525-4TL140		25	25	140	60	4		
ETD4N2525-4TL180		25	25	180	100	4		
ETD4N2625-4TL150		26	25	150	35	4		
ETD4N3232-5TL150		32	32	150	70	5		
ETD4N3232-5TL200		32	32	200	120	5		
ETD4N3532-5TL150		35	32	150	35	5		
ETD4N4032-6TL220		40	32	220	45	6		



Modular End Mill

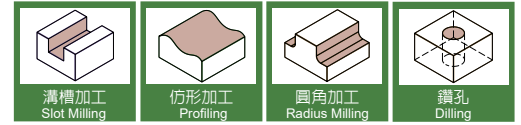

▼ Recommended Inserts 建議刀片品牌: HITACHI

Order No.	Insert	Dimensions(mm)						Screw	Wrench
		刀徑 DC	柄徑 DCON	總長 OAL	長度 LF	螺紋 CRKS	刃數 I No.		
HTD4N-2016M-2	ENMU0603ER-C ENMU0603ER-B	16	8.5	43	25	M08	2	CS25065	FT-8
HTD4N-2017M-2		17	8.5	43	25	M08	2		
HTD4N-2020M-3		20	10.5	49	30	M10	3		
HTD4N-2021M-3		21	10.5	49	30	M10	3		
HTD4N-2025M-4		25	12.5	57	35	M12	4		
HTD4N-2025M-4		25	12.5	57	35	M12	4		
HTD4N-2026M-4		26	12.5	57	35	M16	4		
HTD4N-2032M-5		32	17	62	40	M16	5		
HTD4N-2035M-5		35	17	62	40	M16	5		



High feed Modular end mills

Double sided insert with 4 cutting edges

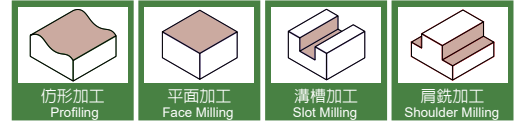
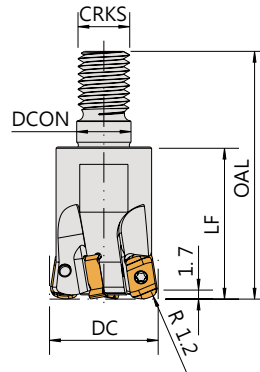

▼Recommended Inserts 建議刀片品牌: DIJET

Order No.	Insert	Dimensions(mm)						Screw	Wrench
		刀徑	柄徑	總長	長度	螺紋	刃數		
Right / Left		DC	DCON	OAL	LF	CRKS	I No.		
MXG2016-M8	ENMU100412	16	5.5	42	25	M8	2	CS25055	FT-8
MXG2017-M8		17	5.5	42	25	M8	2		
MXG2018-M8		18	5.5	42	25	M8	2		
MXG3020-M10		20	5.5	42	30	M10	3	CS25065	
MXG3022-M10		22	5.5	49	30	M10	3		
MXG4025-M12		25	5.5	49	35	M12	4		
MXG4028-M12		28	5.5	57	35	M12	4		
MXG5032-M16		32	6	57	40	M16	5		
MXG5035-M16		35	6	63	40	M16	5		
MXG6040-M16		40	6	63	40	M16	6		
MXG6042-M16		42	6	63	40	M16	6		

## E45HN09

高進給端銑刀

Double sided insert with 12 cutting edges

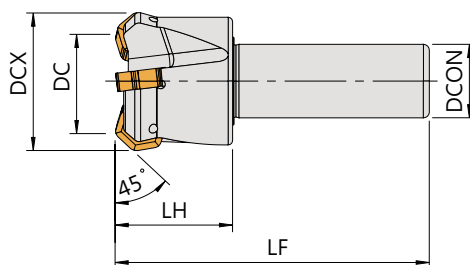

▼Recommended Inserts 建議刀片品牌: KENNAMETAL

Order No.	Insert	Dimensions(mm)					Screw	Wrench
		刀徑	長度	頭長	柄徑	刃數		
Right / Left		DC	LF	LH	DCON	I No.		
E45HN09-D4003R	HNGJ0905 HNPJ0905	40	107	50	32	3	CSR4010	DBIT-T15
E45HN09-D5004R		50	107	50	32	4		

## F45HN09

殼形銑刀

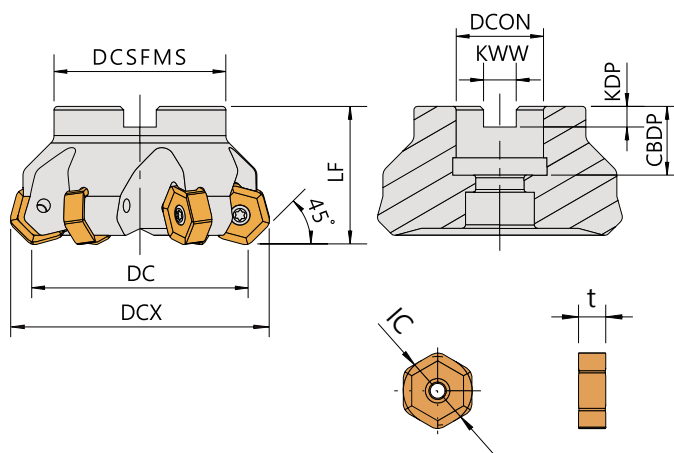

▼Recommended Inserts 建議刀片品牌: KENNAMETAL

Order No.	Insert	Dimensions(mm)						Screw	Wrench
		刀徑	長度	孔徑		刃數	Arbor Type		
Right / Left		DC	LF	DCON	DCON(inch)	I No.			
F45HN09-D050A04R/L x22	HNGJ0905 HNPJ0905	50	40	22	-	4	CSR4010	DBIT-T15	
F45HN09-D063A06R/L x22		63	40	22	1"	6			
F45HN09-D080A06R/L x27		80	50	27	1"	6			
F45HN09-D100B08R/L x32		100	50	32	1-1/4"	8			
F45HN09-D125B10R/L x40		125	63	40	1-1/2"	10			
F45HN09-D160C12R/L x40		160	63	40	-	12			

**EXN**  
高進給銑刀

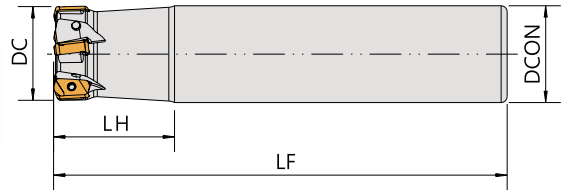
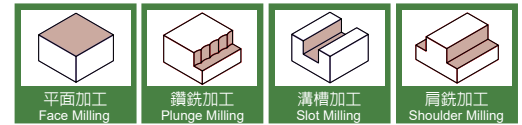

High feed end mills  
Double sided insert with 4 cutting edges

公制型

▼ Recommended Inserts 建議刀片品牌: TUNGALOY / ACC

Order No.	Insert	Dimensions(mm)					Screw	Wrench
		刀徑	柄徑	頭長	長度	刃數		
Right / Left		DC	DCON	LH	LF	I No.		
<b>短頸型 (Short-neck Type)</b>								
EXN03R1602S16	LNMU0303	16	16	20	100	2	CS2508PS	FT-8P
EXN03R1702S16		17	16	20	100	2		
EXN03R2003S20		20	20	25	130	3		
EXN03R2103S20		21	20	25	130	3		
EXN03R2504S25		25	25	30	140	4		
EXN03R2604S25		26	25	30	140	4		
EXN03R3205S32		32	32	40	150	5		
EXN03R3305S32		33	32	40	150	5		
EXN03R3505S32		35	32	40	150	5		
<b>長柄型 (Long Shank)</b>								
EXN03R1602S16-L150B50	LNMU0303	16	16	50	150	2	CS2508PS	FT-8P
EXN03R2003S20-L160B80		20	20	80	160	3		
EXN03R2504S25-L180B100		25	25	100	180	4		
<b>長頸型 (Long-neck Type)</b>								
EXN03R1602S16-B30	LNMU0303	16	16	30	100	2	CS2508PS	FT-8P
EXN03R1702S16-B30		17	16	30	100	2		
EXN03R2003S20-B50		20	20	50	130	3		
EXN03R2103S20-B50		21	20	50	130	3		
EXN03R2504S25-B60		25	25	60	140	4		
EXN03R2604S25-B60		26	25	60	140	4		
EXN03R3205S32-B70		32	32	70	150	5		
EXN03R3305S32-B70		33	32	70	150	5		
EXN03R3505S32-B70		35	32	70	150	5		

**EXN**  
高進給銑刀

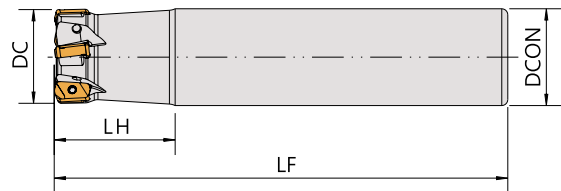
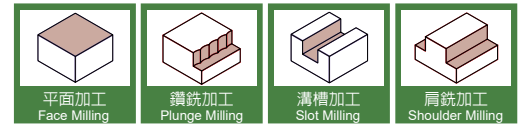

High feed end mills  
Double sided insert with 4 cutting edges

**英制型**

▼Recommended Inserts 建議刀片品牌: TUNGALOY / ACC

Order No.	Insert	Dimensions					Screw	Wrench
		刀徑	柄徑	頭長	長度	刃數		
Right / Left		DC	DCON	LH	LF	I No.		
英制 (inch)								
EXN03R062U0062-02	LNMU0303	.6250	.625	1.250	4.000	2	CS2508PS	FT-8P
EXN03R068U0062-02		.6880	.625	1.250	4.000	2		
EXN03R075U0075-03		.7500	.750	2.000	5.000	3		
EXN03R087U0075-03		.8750	.750	2.000	5.000	3		
EXN03R100U0100-04		1.0000	1.000	2.500	5.500	4		
EXN03R112U0100-04		1.1250	1.000	2.500	5.500	4		
EXN03R125U0125-06		1.2500	1.250	3.000	6.000	6		

**TXN**  
殼形銑刀

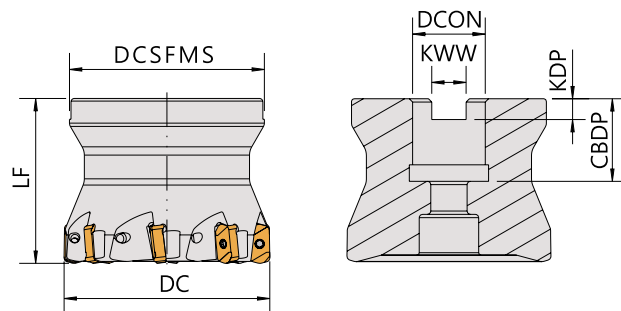
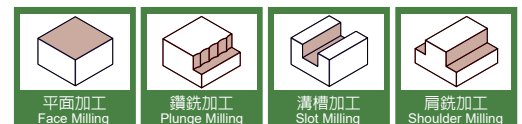

High feed shell end mills  
Double side insert with 4 cutting edges

▼Recommended Inserts 建議刀片品牌: TUNGALOY / ACC

Order No.	Insert	Dimensions(mm)					Screw	Wrench
		刀徑	長度	孔徑		刃數		
Right / Left		DC	LF	DCON	DCON(inch)	I No.		
TXN03R4006	LNMU0303	40	40	16	-	6	CS2508PS	FT-8P
TXN03R5007		50	50	22	-	7		
TXN03R6308		63	50	22	1"	8		





Modular End Mill

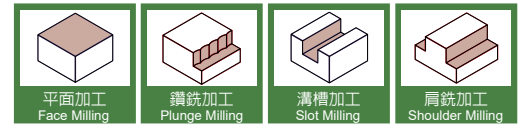

High feed shell end mills  
Double side insert with 4 cutting edges

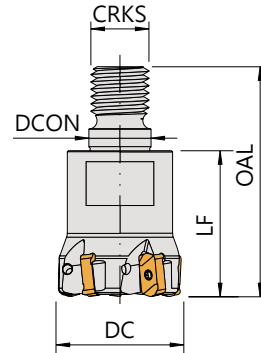

▼ Recommended Inserts 建議刀片品牌: TUNGALOY / ACC

Order No.	Insert	Dimensions(mm)						Screw	Wrench
		刀徑	柄徑	總長	長度	螺紋	刃數		
Right / Left		DC	DCON	OAL	LF	CRKS	I No.		
HXN03R1602	LNMU0303	16	8.5	42	25	M8	2	CS2508PS	FT-8P
HXN03R1702		17	8.5	42	25		2		
HXN03R2003		20	10.5	49	30	M10	3		
HXN03R2103		21	10.5	49	30		3		
HXN03R2504		25	12.5	57	35	M12	4		
HXN03R2604		26	12.5	57	35		4		
HXN03R3205		32	17	63	40	M16	5		
HXN03R3305		33	17	63	40		5		
HXN03R3505		35	17	63	40		5		

▼ Inserts刀片:

●: Stock / ◎: 1st Choice, ○: 2nd Choice, X: Not Recommend

Tolerance Class 精度	P	鋼 Carbon Steels		◎	◎	◎					
	M	不鏽鋼 Stainless Steels		◎							
M級	K	鑄鐵 Cast Iron	◎								
	S	高溫合金 Superalloys	○								
	H	高硬度 Hard Materials	○								
Specification 規格			Grade 材質				Dimensions(mm) 尺寸				
			AH725	AH3035	AH130	NA253A	IC	t	B	r	Max.ap
LNMU0303ZER-MJ			●	●	●	●	6.0	4.3	6.0	1.2	1
LNMU0303ZER-ML			●	●	●		6.0	4.3	6.0	1.2	1

F90LN15

殼型銑刀

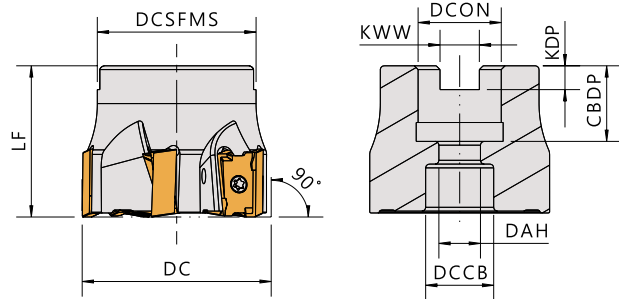
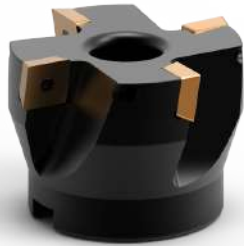

▼ Recommended Inserts 建議刀片品牌: KENNAMETAL

Order No.	Insert	Dimensions(mm)					Screw	Wrench
		刀徑 DC	長度 LF	孔徑 DCON		刃數 I No.		
F90LN15-040-04	LNGU15T608SRGEM	40	40	16	-	4	CSR4010	DBIT-T15
F90LN15-050-05		50	46	22	-	5		
F90LN15-063-06		63	46	22	1"	6		
F90LN15-080-07		80	50	27	1"	7		

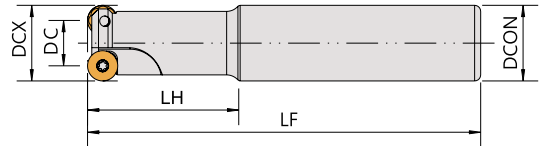

▼ Recommended Inserts 建議刀片品牌: SUMITOMO

Order No.	Insert	Dimensions(mm)						Screw	Wrench
		最大刀徑	刀徑	柄徑	長度	頭長	刃數		
Right / Left		DCX	DC	DCON	LF	LH	I No.		
MWRC12-12-110-08-40	QPMT080330PPEN	12	10	12	110	40	1	CS25055	DT-8
MWRC12-12-150-08-70		12		12	150	70	1		
MWRC16-16-120-08-50		16	14	16	120	50	1	CS25065	
MWRC16-16-150-08-70		16		16	150	70	1		
MWRC20-20-130-08-50		20	18	20	130	50	2	CS35090	
MWRC20-20-180-08-100		20		20	180	100	2		
MWRC25-25-130-10-50	QPMT10T335PPEN	25	21	25	130	50	2	CS35090	DBIT-T15
MWRC25-25-180-10-100		25		25	180	100	2		
MWRC32-32-130-10-50		32	28	32	130	50	3		
MWRC32-32-200-10-120		32		32	200	120	3		
MWRC32-32-300-10-180		32		32	300	180	3		
MWRC32-32-200-12-120	QPMT120440PPEN	32		32	200	120	2	CS40090	
MWRC40-32-170-16	QPMT160660PPEN	40	31.3	32	170	50	2	CS50100	DBIT-T20
MWRC40-32-250-16		40		32	250		2		
MWRC50-32-170-16		50	40.8	32	170		3	CS50130	
MWRC50-32-250-16		50		32	250		3		



R END MILLS

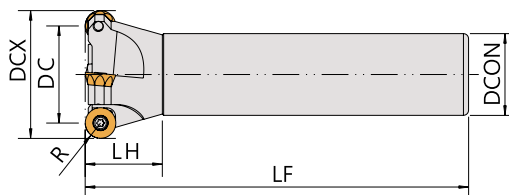

▼ Recommended Inserts 建議刀片品牌: MITSUBISHI

Order No.	Insert	Dimensions(mm)						Screw	Wrench
		最大刀徑	刀徑	柄徑	長度	頭長	刃數		
Right / Left		DCX	DC	DCON	LF	LH	I No.		
EM4R-D16K01	RPMT08T2MOE	16	8	16	120	30	1	CS25065	DT-8
EM4R-D16M01		16	8	16	150	30	1		
EM4R-D16R01		16	8	16	200	30	1		
EM4R-D20K02		20	12	20	120	30	2		
EM4R-D20M02		20	12	20	150	30	2		
EM4R-D20R02		20	12	20	200	30	2		
EM4R-D25K03		25	17	20	120	35	3		
EM4R-D25M03		25	17	20	150	35	3		
EM4R-D25R03		25	17	20	200	35	3		
EM5R-D25K02	RPMT10T3MOE	25	15	25	120	40	2	CS35090	DBIT-T15
EM5R-D25M02		25	15	25	150	40	2		
EM5R-D25R02		25	15	25	200	40	2		
EM5R-D30K03		30	20	25	120	40	3		
EM5R-D30M03		30	20	25	150	40	3		
EM5R-D30R03		30	20	25	200	40	3		
EM5R-D35K03		35	25	32	120	40	3		
EM5R-D35M03		35	25	32	150	40	3		
EM5R-D35R03		35	25	32	200	50	3		
EM6R-D35K02	RPMT1204MOE	35	23	32	120	50	2	CS35090	DBIT-T15
EM6R-D35M02		35	23	32	150	50	2		
EM6R-D35R02		35	23	32	200	50	2		
EM6R-D40K03		40	28	32	120	50	3		
EM6R-D40M03		40	28	32	150	50	3		
EM6R-D40R03		40	28	32	200	50	3		
EM6R-D50R04		50	38	32	200	50	4		

## MS5R

圓角殼型銑刀

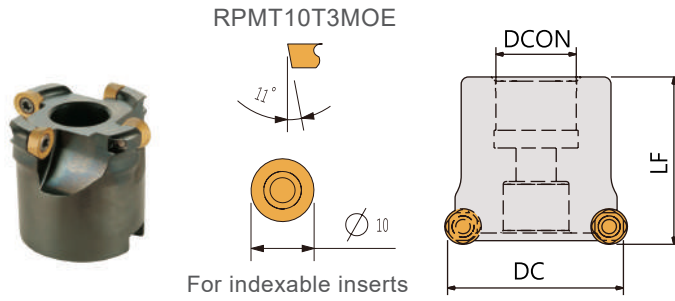

▼ Recommended Inserts 建議刀片品牌: MITSUBISHI

Order No.	Insert	Dimensions(mm)				Screw	Wrench
		刀徑 DC	長度 LF	孔徑 DCON	刃數 I No.		
MS5R-050A04R	RPMT10T3MOE RPMW10T3MOE	50	46	22	4	CS35090	DBIT-T15
MS5R-063A05R		63	46	22	5		
MS5R-080A06R		80	50	27	6		
MS5R-100B07R		100	50	32	7		

## MS6R

圓角殼型銑刀

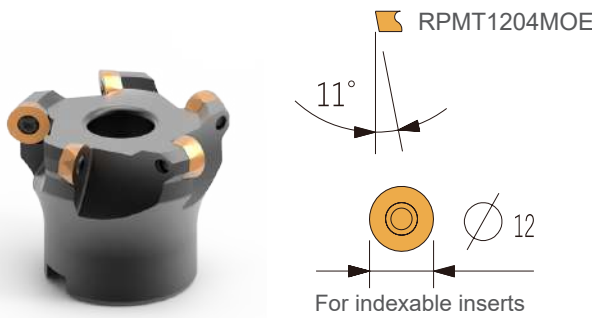

▼ Recommended Inserts 建議刀片品牌: MITSUBISHI

Order No.	Insert	Dimensions(mm)				Screw	Wrench
		刀徑 DC	長度 LF	孔徑 DCON	刃數 I No.		
MS6R-050A04R	RPMT1204MOE RPMW1204MOE	50	46	22	4	CS35090	DBIT-T15
MS6R-063A05R		63	46	22	5		
MS6R-080A06R		80	50	27	6		
MS6R-100B07R		100	50	32	7		
MS6R-125B08R		125	54	40	8		
MS6R-080A06RN	RPMT1204MOE RPMW1204MOE	80	50	27	6	CS40090	DBIT-T15
MS6R-100B07RN		100	50	32	7		

▼ Inserts 刀片:

●: Stock / ○: 1st Choice, ○: 2nd Choice, X: Not Recommend

Tolerance Class 精度	P	鋼 Carbon Steels	○	○	○	○				
	M	不鏽鋼 Stainless Steels	○	○	○	○				
M級	K	鑄鐵 Cast Iron	○		○					
Specification 規格			Grade 材質				Dimensions(mm) 尺寸			
			VS203	SPTIEH	F7030	VP15TF	IC	T	d	α
RPMT1204MOE					●	●	12	4.76	4.4	11

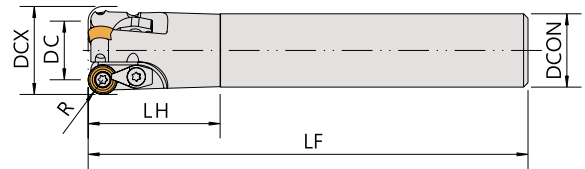

▼ Recommended Inserts 建議刀片品牌: HITACHI

Order No.	Insert	Dimensions(mm)						Screw	Clamp	Wrench
Right / Left		最大刀徑	刀徑	柄徑	長度	頭長	刃數			
		DCX	DC	DCON	LF	LH	I No.			
ERD10-2525M02	RDMT10T3	25	15	25	150	45	2	CS35091	CP50-27AS	DBIT-T15
ERD10-2525R02		25	15	25	200	45	2			
ERD10-3025M03		30	20	25	150	45	3			
ERD10-3025R03		30	20	25	200	45	3			
ERD10-3532M03		35	25	32	150	45	3			
ERD10-3532R03		35	25	32	200	45	3			

▼ Inserts刀片:

●: Stock / ◎: 1st Choice, ○: 2nd Choice, X: Not Recommend

Tolerance Class 精度	P	鋼 Carbon Steels	◎	◎	◎	◎				
	M	不鏽鋼 Stainless Steels	◎	◎	◎	◎				
M級	K	鑄鐵 Cast Iron	◎		◎					
Specification 規格			Grade 材質				Dimensions(mm) 尺寸			
◎			VS203	SPTIEH	F7030	VP15TF	IC	T	d	α
RDMT10T3MOE			●	●	●	●	10	3.97	4.5	15

## MSRD10

圓角殼型銑刀

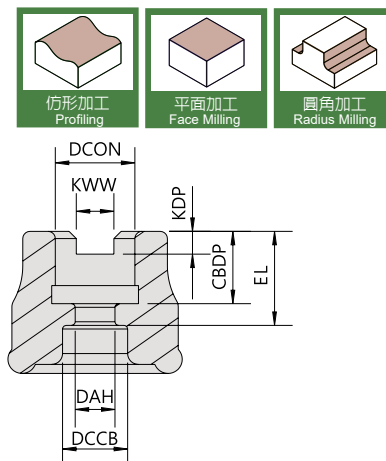
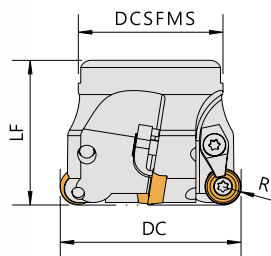

▼Recommended Inserts 建議刀片品牌: HITACHI

Order No.	Insert	Dimensions(mm)				Screw	Clamp	Wrench
Right / Left		刀徑 DC	長度 LF	孔徑 DCON	刃數 I No.			
MSRD10-050-04	RDMT10T3	50	40	22	4	CS35091	CP50-27AS	DBIT-T15
MSRD10-063-05		63	40	22	5			
MSRD10-080-06		80	50	27	6			
MSRD10-100-07		100	50	32	7			
MSRD10-125-08		125	55	40	8			

## MSRD12

圓角殼型銑刀

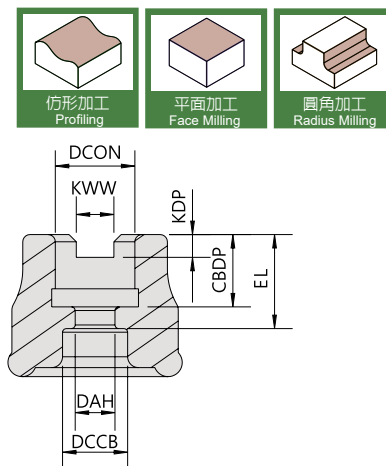
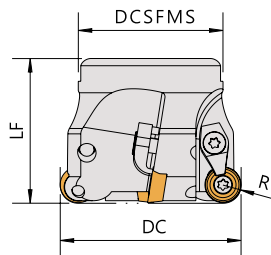

▼Recommended Inserts 建議刀片品牌: HITACHI

Order No.	Insert	Dimensions(mm)				Screw	Clamp	Wrench
Right / Left		刀徑 DC	長度 LF	孔徑 DCON	刃數 I No.			
MSRD12-050-04	RDMT1204	50	40	22	4	CS4009P	CP50-27AS	DBIT-TP15
MSRD12-063-05		63	40	22	5			
MSRD12-080-06		80	50	27	6			
MSRD12-100-07		100	50	32	7			
MSRD12-125-08		125	55	40	8			





Modular End Mill

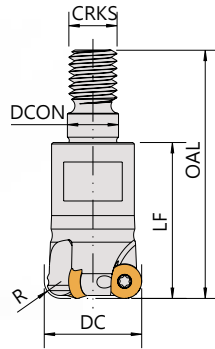

▼ Recommended Inserts 建議刀片品牌: HITACHI

Order No.	Insert	Dimensions(mm)						Screw	Wrench
Right / Left		刀徑	柄徑	總長	長度	螺紋	刃數		
		DC	DCON	OAL	LF	CRKS	I No.		
ERD05-09-2T-M05	RDHX0501	9	5.5	27.5	15	M5	2	CS20038	FT-6
ERD05-10-2T-M05		10	5.5	28.5	16		2		
ERD05-11-2T-M05		11	5.5	30.5	18		2		
ERD05-12-2T-M06		12	6.5	32.5	18	M6	2		
ERD05-13-2T-M06		13	6.5		18		2		
ERD05-13-3T-M06		13	6.5		18		3		
ERD05-16-4T-M08		16	8.5	41	23	M8	4		
ERD05-17-4T-M08		17	8.5		23		4		
ERD07-12-2T-M06	RDMT0702	12	6.5	37.5	23	M6	2	CS25055	FT-8
ERD07-15-2T-M08		15	8.5		23	M8	2		
ERD07-16-2T-M08		16	8.5	41	23		2		
ERD07-16-3T-M08		16	8.5		23		3		
ERD07-17-2T-M08		17	8.5	43	25	M10	2		
ERD07-17-3T-M08		17	8.5		25		3		
ERD07-20-3T-M10		20	10.5	51	32		3		
ERD07-21-2T-M10		21	10.5		32	2			
ERD07-21-3T-M10		21	10.5		32	3			
ERD07-22-3T-M10		22	10.5		32	3			
ERD07-25-4T-M12		25	12.5	57	35	M12	4		
ERD07-26-4T-M12		26	12.5		35		4		
ERD07-26-5T-M12		26	12.5		35		5		
ERD07-35-5T-M16	35	17	65	43	M16	5			

## ER390

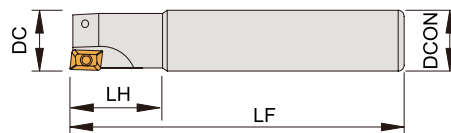
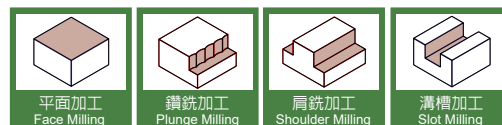

▼Recommended Inserts 建議刀片品牌: SANDVIK

Order No.	Insert	Dimensions(mm)					Screw	Wrench
		刀徑	長度	頭長	柄徑	刃數		
Right / Left		DC	LF	LH	DCON	I No.		
ER390-162S16-100	R390-11T3	16	100	20	16	2	CS25055	DT-8
ER390-162S16-150		16	150	20	16	2		
ER390-172S16-150		17	150	20	16	2		
ER390-203S20-110		20	110	25	20	3	CS25065	
ER390-203S20-150		20	150	25	20	3		
ER390-213S20-150		21	150	25	20	3		
ER390-253S25-200		25	200	30	25	3		
ER390-254S25-120		25	120	30	25	4		
ER390-254S25-150		25	150	30	25	4		
ER390-264S25-150		26	150	30	25	4		
ER390-324S32-200		32	200	40	32	4		
ER390-325S32-150		32	150	40	32	5		
ER390-335S32-150		33	150	40	32	5		

## R390

### 殼形銑刀

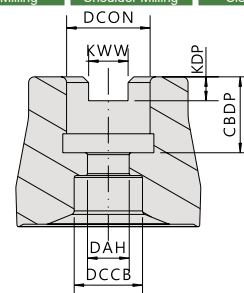
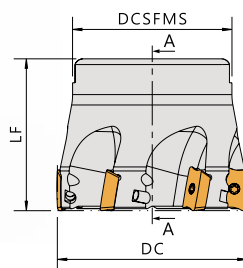

▼Recommended Inserts 建議刀片品牌: SANDVIK

Order No.	Insert	Dimensions(mm)				Screw	Wrench
		刀徑	長度	柄徑	刃數		
Right / Left		DC	LF	DCON	I No.		
R390-F50-6T	R390-11T3	50	40	22	6	CS25065	FT-8
R390-F52-5T		52	40	22	5		
R390-F63-8T		63	40	22	8		
R390-F66-7T		66	40	22	7		
R390-F80-8T		80	50	27	8		



## E90SD12

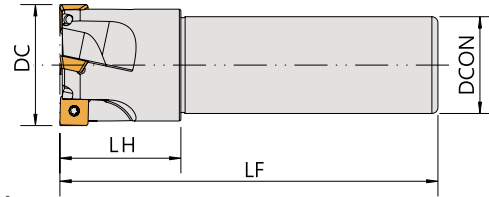
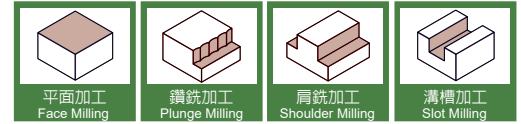

▼ Recommended Inserts 建議刀片品牌: KENNAMETAL / KYOCERA

Order No.	Insert	Dimensions(mm)					Screw	Wrench
Right / Left		刀徑	長度	頭長	柄徑	刃數		
		DC	LF	LH	DCON	I No.		
E90SD12-D32K02	SDPT1204PDEN	32	125	35	32	2	CS35090	DBIT-T15
E90SD12-D40K02		40	125	40	32	3		
E90SD12-D50K03		50	125	40	32	5		

## F90SD12

殼形銑刀

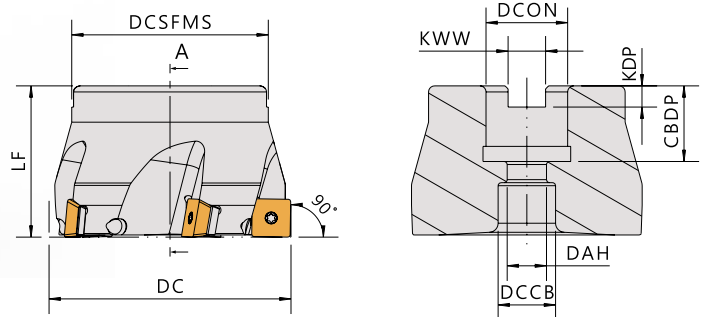
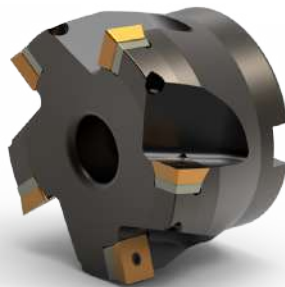
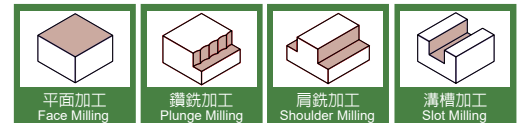

▼ 少刃型/有墊片

▼ Recommended Inserts 建議刀片品牌: KENNAMETAL

Order No.	Insert	Dimensions(mm)					Shim	Shim Screw	Screw	Wrench
Right / Left		刀徑	長度	孔徑		刃數				
		DC	LF	DCON	DCON(inch)	I No.				
F90SD12-D050A03RSH	SDMT1204	50	46	22	-	5	-	-	CS35119S	DBIT-T15
F90SD12-D063A06RH		63	46	22	1"	6	-	-		
F90SD12-D080B05RS		80	50	27	1"	7	SMS321	SN535		
F90SD12-D100B06RS		100	50	32	1-1/4"	10	SMS321	SN535		
F90SD12-D125B12R		125	61	40	1-1/2"	12	-	-		

F90SD12-D100B06RS with shim 墊片型

F90SD12-D050A05RH with cooling channel 無墊片，只有出水

F90SD12-D063A04RSH with shim and cooling channel 墊片+出水

F90SD12-D080B07R without shim and cooling channel 無墊片+無出水

## SSD12

殼形銑刀

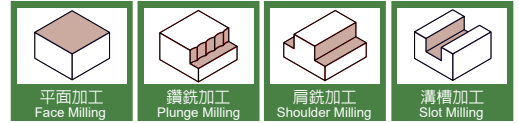
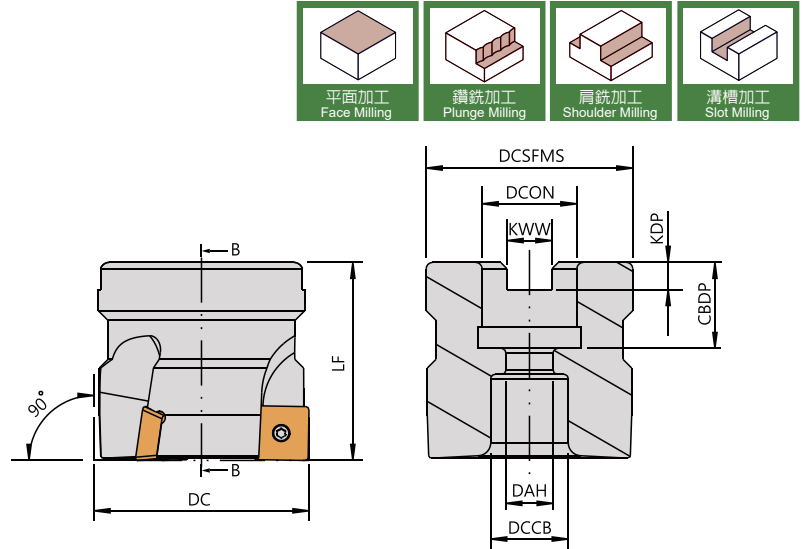

▼多刃型/無墊片

▼Recommended Inserts 建議刀片品牌: KENNAMETAL / KYOCERA

💧 Standard with Coolant hole

Order No.	Insert	Dimensions(mm)					Screw	Wrench
		刀徑	長度	孔徑		刃數		
Right / Left		DC	LF	DCON	DCON(inch)	I No.		
SSD12-040-04RH	SDPT1204 SDMT1204 SDMT1205	40	40	16	-	4	CS35119S	DBIT-T15
SSD12-050-05RH		50	40	22	-	5		
SSD12-063-06RH		63	40	22	1"	6		
SSD12-080-07RH		80	50	27	1"	7		
SSD12-100-08RH		100	50	32	1-1/4"	8		

## E45SE12

倒角刀

Chamfer Milling Cutter

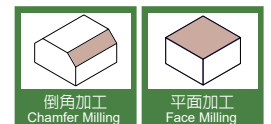
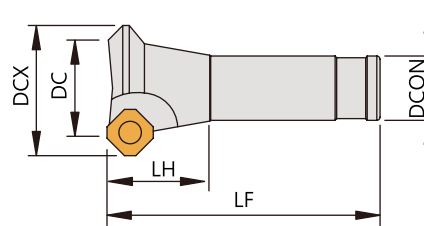

Order No.	Insert	Dimensions(mm)						Screw	Wrench
		刀徑	柄徑	最大刀徑	長度	頭長	刃數		
Right / Left		DC	DCON	DCX	LF	LH	I No.		
E45SE12-D25H02	SEHW1204AFTN SEKT1204	25	20	37	100	31	2	CS45090	DBIT-T15
E45SE12-D30H02		30	20	42	100	31	2		
E45SE12-D40J03		40	25	52	110	37	3		
E45SE12-D50K04		50	32	62	125	37	4		
E45SE12-D63M05		63	32	75	150	37	5		

## E90SE09

直角端銑刀

New generation of 90° face and shoulder Milling cutter with screw-on inserts Low costs per cutting edge through Indexable insert with four edges

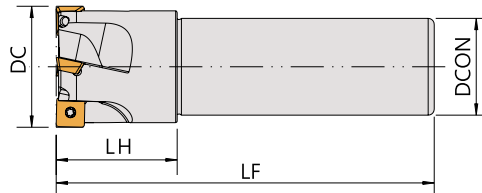
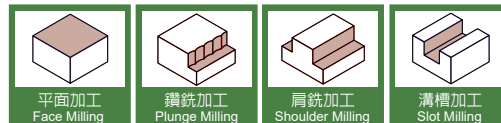

▼ Recommended Inserts 建議刀片品牌: KYOCERA

Order No.	Insert	Dimensions(mm)					Screw	Wrench
Right / Left		刀徑	長度	頭長	柄徑	刃數		
	DC	LF	LH	DCON	I No.			
E90SE09-D25JX02	SEMM09T3	25	120	30	25	2	CS30070	DBIT-T10
E90SE09-D32K03		32	125	35	32	3		
E90SE09-D40K04		40	125	40	32	4		
E90SE09-D50K05		50	125	40	32	5		

## F90SE09

直角殼型銑刀

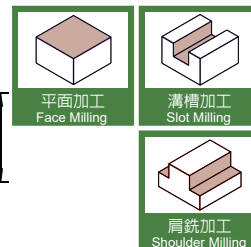
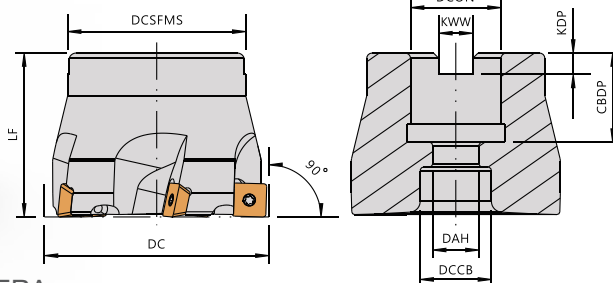

▼ Recommended Inserts 建議刀片品牌: KYOCERA

Order No.	Insert	Dimensions(mm)					Screw	Wrench
Right / Left		刀徑	長度	孔徑		刃數		
	DC	LF	DCON	DCON(inch)	I No.			
F90SE09-D40A04R	SEMM09T3	40	40	16	-	4	CS30070	DBIT-T10
F90SE09-D50A05R		50	46	22	-	5		
F90SE09-D63A05R		63	46	22	1"	5		
F90SE09-D80B06R		80	50	27	1"	6		
F90SE09-D100B08R		100	50	32	1-1/4"	8		
F90SE09-D125B10R		125	55	40	1-1/2"	10		

▼ Inserts刀片:

●: Stock / ◎: 1st Choice, ○: 2nd Choice, X: Not Recommend

Tolerance Class 精度	P	鋼 Carbon Steels	○	◎			
M級	M	不鏽鋼 Stainless Steels	○	◎			
	K	鑄鐵 Cast Iron	◎				
Specification 規格	Grade 材質		Dimensions(mm) 尺寸				
	<b>AK105</b>	<b>TP205</b>	<b>IC</b>	<b>T</b>	<b>d</b>	<b>α</b>	<b>r</b>
SEMM09T308PESR	●	●	9.52	3.97	3.4	15	0.8

**E908**

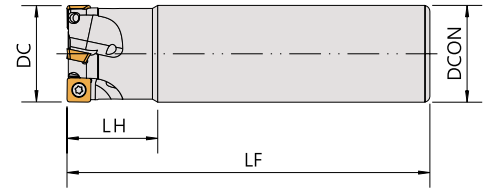
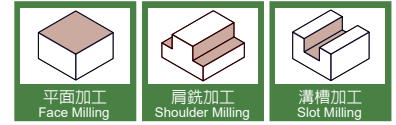

Standard with Coolant hole

▼ Recommended Inserts 建議刀片品牌: SUMITOMO

Order No.	Insert	Dimensions(mm)					Screw	Wrench
		刀徑 DC	柄徑 DCON	頭長 LH	長度 LF	刃數 I No.		
Right / Left								
E908-2016-02-110H	SOMT0803 SOET0803	20	16	30	110	2	CS30055PS	FT-8P
E908-2020-02-110H		20	20	30	110	2		
E908-2220-02-120H		22	20	30	120	2		
E908-2520-02-120H		25	20	30	120	2		
E908-2525-03-120H		25	25	30	120	2		
E908-2825-02-120H		28	25	30	120	2		
E908-3025-03-120H		30	25	30	120	3		
E908-3232-03-120H		32	32	30	120	3		
E908-3332-03-120H		33	32	30	120	3		
E908-4032-03-120H		40	32	30	120	3		
E908-5032-04-120H		50	32	30	120	4		
E908-6332-05-120H		63	32	30	120	5		

E908-2016-02-110 without cooling channel 無油孔

E908-2016-02-110H with cooling channel 含油孔

E908-2016-02-110LH with longer shank and cooling channel 加長型含油孔

**E912**

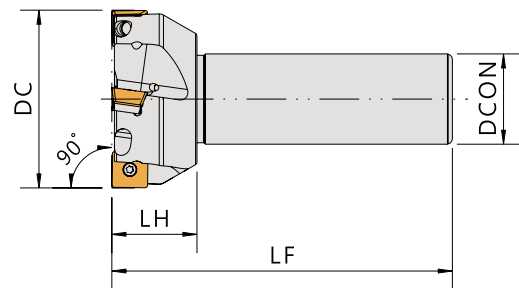

▼ Recommended Inserts 建議刀片品牌: SUMITOMO

Standard with Coolant hole

Order No.	Insert	Dimensions(mm)					Screw	Wrench
		刀徑 DC	柄徑 DCON	頭長 LH	長度 LF	刃數 I No.		
Right / Left								
E912-4032-03-120H	SOMT1204	40	32	30	120	3	CS35117S	DBIT-T15
E912-5032-03-120H		50	32	30	120	3		
E912-5032-04-120H		50	32	30	120	4		
E912-6332-04-120H		63	32	30	120	4		
E912-6332-05-120H		63	32	30	120	5		
E912-8032-04-120H		80	32	30	120	4		
E912-8032-06-120H		80	32	30	120	6		

E912-4032-03-120 without cooling channel 無油孔

E912-4032-03-120H with cooling channel 含油孔

E912-4032-03-120LH with longer shank and cooling channel 加長型含油孔



## MS908

殼形銑刀

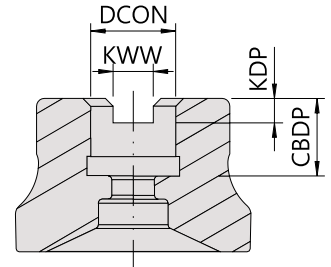
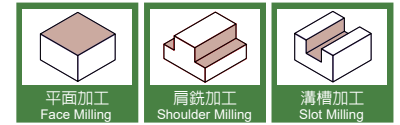
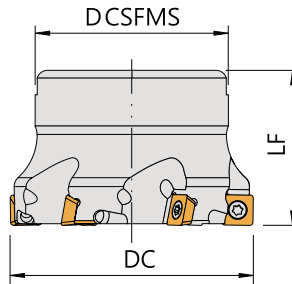

Standard with Coolant hole

▼ Recommended Inserts 建議刀片品牌: SUMITOMO

Order No.	Insert	Dimensions(mm)					Screw	Wrench
		刀徑	長度	孔徑		刃數		
Right / Left		DC	LF	DCON	DCON(inch)	I No.		
MS908-040-04H	SOMT0803 SOET0803	40	40	16	-	4	CS30055PS	FT-8P
MS908-050-05H		50	40	22	-	5		
MS908-063-06H		63	40	22	-	6		
MS908-080-08H		80	50	27	1"	8		
MS908-100-10H		100	50	32	1-1/4"	10		

MS908-040-04 without cooling channel 無油孔

MS908-040-04H with cooling channel 含油孔

## MS912

殼形銑刀

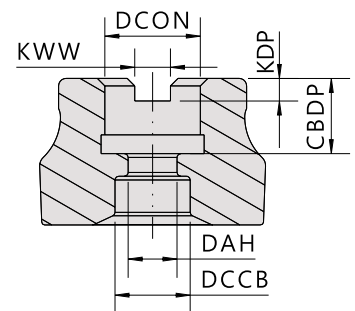
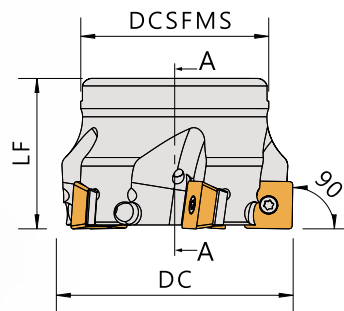

Standard with Coolant hole

▼ Recommended Inserts 建議刀片品牌: SUMITOMO

Order No.	Insert	Dimensions(mm)					Shim	Screw		Wrench	
		刀徑	長度	孔徑		刃數					
Right / Left		DC	LF	DCON	DCON(inch)	I No.					
MS912-063-05H	SOMT1204	63	40	22	1"	5	SMS321	SN535	CS35117S	DBIT-T15	LW035
MS912-080-06H		80	50	27	1"	6					
MS912-100-07H		100	63	32	1-1/4"	7					

MS908-050-04H with cooling channel 含油孔

## ASX400

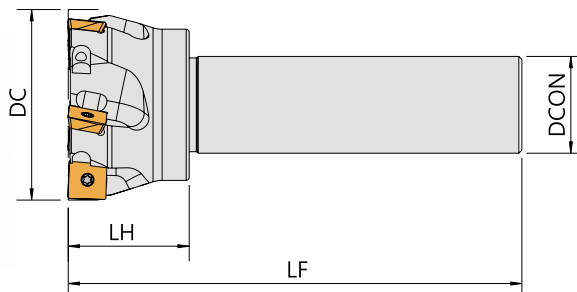

▼Recommended Inserts 建議刀片品牌: MITSUBISHI

Order No.	Insert	Dimensions(mm)					Screw	Wrench
		刀徑 DC	柄徑 DCON	頭長 LH	長度 LF	刃數 I No.		
ASX400R504S20-150	SOMT12T308	50	20	40	150	4	CS35117S	DBIT-T15
ASX400R403S32-150		40	32	40	150	3		
ASX400R635S32-150		63	32	40	150	5		

## ASX4RS

W/ SHIM

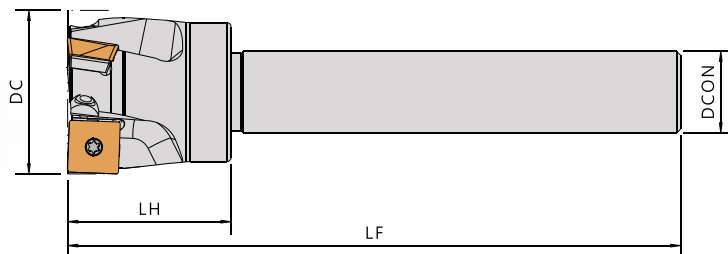

▼Recommended Inserts 建議刀片品牌: MITSUBISHI

Order No.	Insert	Dimensions(mm)					Shim	Shim Screw	Screw	Wrench
		刀徑 DC	柄徑 DCON	頭長 LH	長度 LF	刃數 I No.				
ASX4RS322S20-150	SOMT12T308	32	20	40	150	2	SMS321	SN535	CS35117S	DBIT-T15
ASX4RS403S20-150		40	20	40	150	3				
ASX4RS504S20-150		50	20	40	150	4				
ASX4RS403S32-150		40	32	40	150	3				
ASX4RS504S32-150		50	32	40	150	4				
ASX4RS635S32-150		63	32	40	150	5				

**ASX4-S**  
W/ SHIM

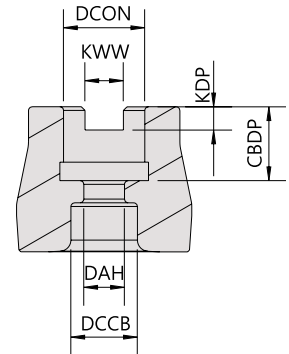
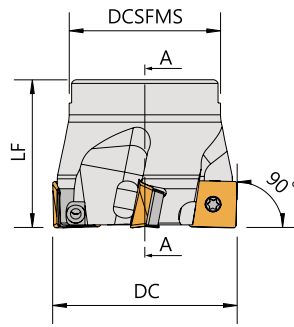
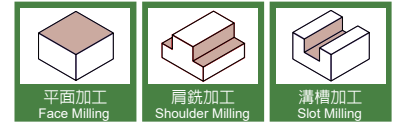

▼ Recommended Inserts 建議刀片品牌: MITSUBISHI

Order No.	Insert	Dimensions(mm)						Shim	Shim Screw	Screw	Wrench
Right / Left		刀徑	長度	孔徑		夾持接觸面直徑	刃數				
		DC	LF	DCON	DCON(inch)	DCSFMS	I No.				
ASX4-05004RS	SOMT 12T308	50	40	22	-	41	4	SMS321	SN535	CS35117S	
ASX4-06305RS		63	40	22	1"	50	5				
ASX4-08004RS		80	50	-	1"	60	4				
ASX4-08006RS		80	50	27	1"	60	6				
ASX4-10007RS		100	50	32	1-1/4"	70	7				
ASX4-12508RS		125	63	40	1-1/2"	80	8				
ASX4-16012RS		160	63	40	2"	100	12				
ASX4-20016RS		200	63	60	-	160	16				
ASX4-25018RS		250	63	60	-	210	18				



Positive Axial Rake

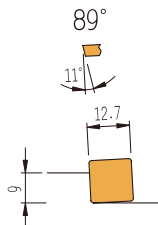

For indexable inserts  
SP 1203

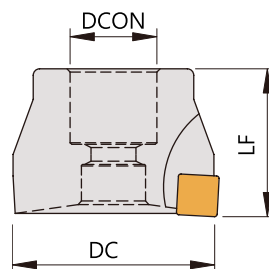
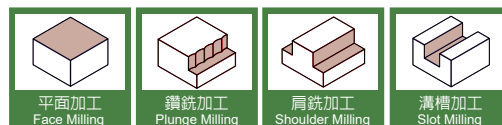

Order No.	Insert	Dimensions(mm)					Clamp	Screw	Spring	Wrench
Right / Left		刀徑	長度	孔徑		刃數				
		DC	LF	DCON	DCON (inch)	I No.				
MS50S	SP**1203	50	46	22	-	3	CP50-3	CSB0617T	SP030	TL-25
MS63S		63	46	27	1"	4				
MS75S		75	46.5	27	1"	5				
MS100S		100	50	32	1-1/4"	6				



倒角刀

Chamfer Milling Cutter

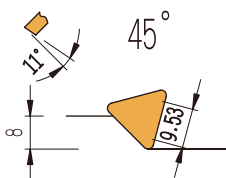

For indexable inserts  
TP 1603

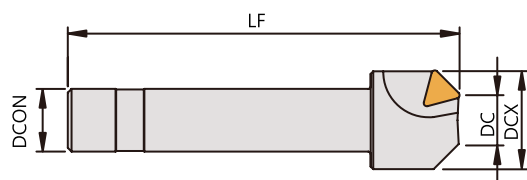
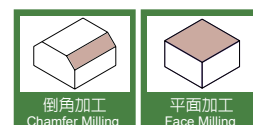

Order No.	Insert	Dimensions(mm)					Clamp	Screw	Wrench
Right / Left		刀徑	長度	柄徑	最大刀徑	刃數			
		DC	LF	DCON	DCX	I No.			
ME05C x12	TP**1603	5	100	12	25	1	CP50-5	CS70-11	LW040
ME05C		5	100	20	25	1			
ME10C		10	120	20	29	2			
ME20C x12		20	156	12	40	3			
ME20C x16		20	156	16	40	3			
ME20C x20		20	156	20	40	3			
ME20C x25		20	156	25	40	3			



-Straight Shank  
90°shoulder.

Positive  
Axial Rake

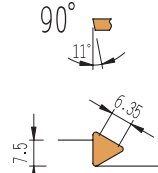
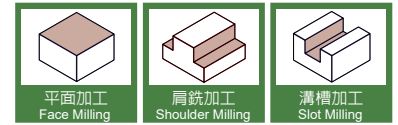

For indexable inserts  
TP 1102, TP 1103

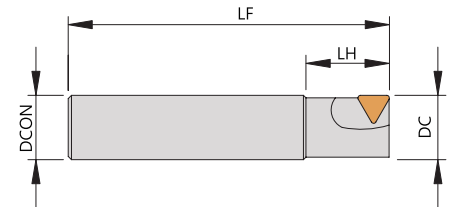

Order No.	Insert	Dimensions(mm)					Clamp	Screw	Wrench
Right / Left		刀徑 DC	長度 LF	頭長 LH	柄徑 DCON	刃數 I No.			
ME16T	TP**1102	16	100	26	16	1	CP50-4	CS70-5	LW030
ME18T		18	100	26	16	1			
ME20T		20	100	26	20	2			
ME22T		22	100	26	20	2			
ME25Tx20		25	100	26	20	2			
ME16TxTP1103	TP**1103	16	100	26	16	1	CP50-4	CS70-5	LW030
ME20TxTP1103		20	100	26	20	2			
ME22TxTP1103		22	100	26	20	2			
ME25Tx25xTP1103		25	100	26	25	2			
ME30Tx25xTP1103		30	100	26	25	2			



-Straight Shank  
90°shoulder.

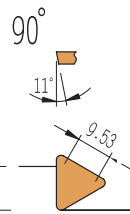

For indexable inserts  
TP 1603

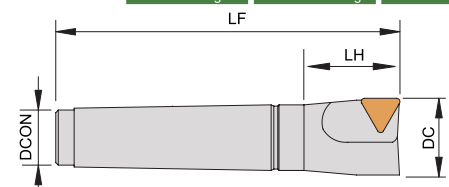

Order No.	Insert	Dimensions(mm)					Clamp	Screw	Spring	Wrench
Right / Left		刀徑 DC	長度 LF	頭長 LH	柄徑 DCON	刃數 I No.				
ME30Tx25	TP**1603	30	114	44	25	2	CP50-3	CSB0617T	SP030	TL-25
ME32Tx25		32	114	44	25	2				
ME32Tx32		32	114	44	32	2				
ME35Tx32		35	114	44	32	2				
ME40Tx32		40	114	44	32	3				
ME45Tx32		45	116	46	32	3				
ME50Tx32		50	116	46	32	3				

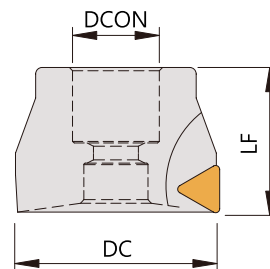
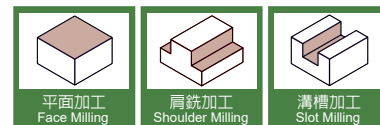
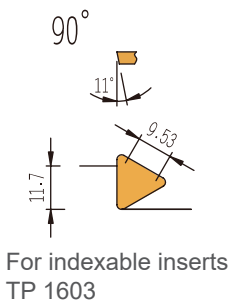

Order No.	Insert	Dimensions(mm)				Clamp	Screw	Spring	Wrench
		刀徑 DC	長度 LF	孔徑 DCON DCON(inch)					
MS50T	TP**1603	50	46	22	-	CP50-3	CSB0617T	SP030	TL-25
MS63T		63	46	27	1"				
MS75T		75	46.5	27	1"				
MS100T		100	50	32	1-1/4"				



Positive Axial Rake

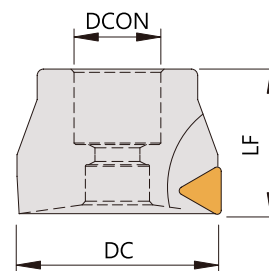
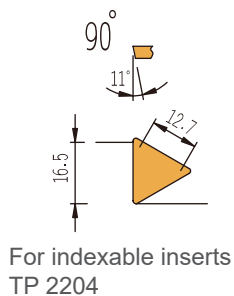

Order No.	Insert	Dimensions(mm)				Shim	Shim Screw	Clamp	Clamp Screw	Wrench
		刀徑 DC	長度 LF	孔徑 DCON DCON(inch)						
MS63T22S	TP**2204	63	50	22	1"	SMT-42	CSA4009F	CP50-10	CS6-8026	LW060
MS80T22S		80	50	27	1"					
MS100T22S		100	50	32	1-1/4"					
MS125T22S		125	61	40	1-1/2"					

## E90XN06

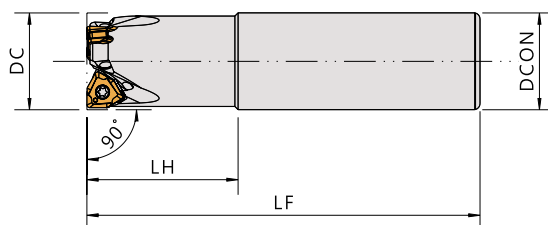
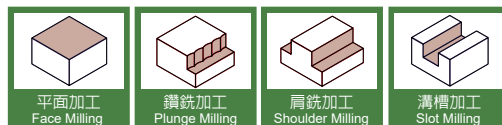

▼Recommended Inserts 建議刀片品牌: SUMITOMO

Order No.	Insert	Dimensions(mm)					Screw	Wrench
Right / Left		刀徑	長度	頭長	柄徑	刃數		
		DC	LF	LH	DCON	I No.		
E90XN06-D3203H	XNMU0606	32	130	50	32	3	BFTX03512IP	TRDR15IP
E90XN06-D4004H		40	130	50	32	4		
E90XN06-D5005H		50	130	50	32	5		
		50	150	50	42	5		
E90XN06-D6306H		63	130	50	32	6		
		63	150	50	42	6		
E90XN06-D8007H		80	130	50	32	7		
		80	150	50	42	7		

## F90XN06

殼形銑刀

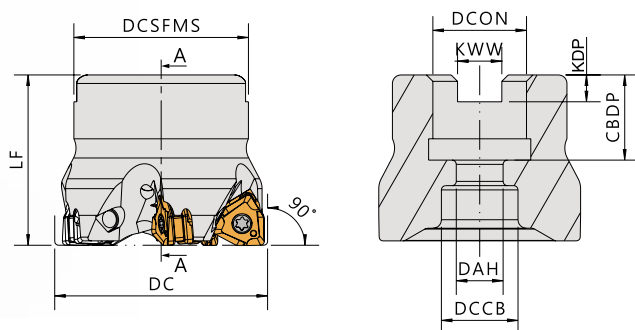
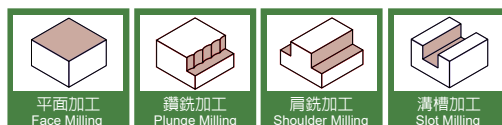

▼Recommended Inserts 建議刀片品牌: SUMITOMO

Order No.	Insert	Dimensions(mm)					Screw	Wrench
Right / Left		刀徑	長度	孔徑		刃數		
		DC	LF	DCON	DCON(inch)	I No.		
F90XN06-05005H	XNMU0606	50	40	22	-	5	BFTX03512IP	TRDR15IP
F90XN06-06306H		63	40	22	-	6		
F90XN06-08007H		80	50	27	1"	7		
F90XN06-10008H		100	50	32	1-1/4"	8		
F90XN06-12511H		125	63	40	1-1/2"	11		
F90XN06-16012		160	63	40	2"	12		
F90XN06-20016		200	63	60	1-7/8"	16		

**E90X06**

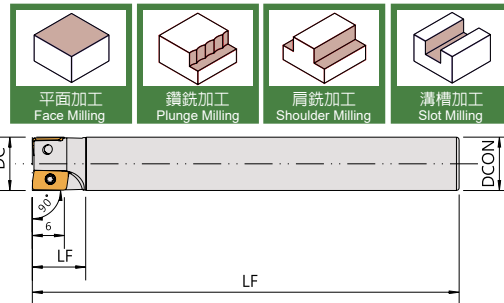

▼ Recommended Inserts 建議刀片品牌: SECO

Order No.	Insert	Dimensions(mm)					Screw	Wrench
		刀徑	長度	頭長	柄徑	刃數		
Right / Left		DC	LF	LH	DCON	I No.		
E90X06-D06F01	XOMT0602	6	80	10	6	1	CS16037S	FT-5
E90X06-D08G01		8	90	10	8	1		
E90X06-D10H02		10	100	10	10	2		



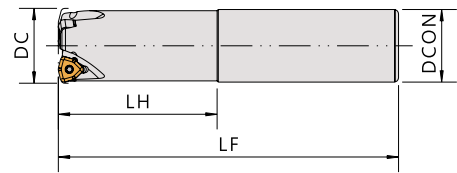

▼Recommended Inserts 建議刀片品牌: KORLOY

Order No.	Insert	Dimensions(mm)					Screw	Wrench
		刀徑 DC	柄徑 DCON	頭長 LH	長度 LF	刃數 I No.		
HRMDS09-2525-2TL140	WNMX09T316ZNN-MM	25	25	60	140	2	CS30070	FT-10
HRMDS09-2625-2TL140		26	25	60	140	2		
HRMDS09-3025-3TL150		30	25	70	150	3		
HRMDS09-3232-3TL150		32	32	70	150	3		
HRMDS09-3332-3TL150		33	32	70	150	3		
HRMDS09-3532-4TL150		35	32	50	150	4		
HRMDS09-4032-4TL150		40	32	50	150	4		

**E90ZC10**

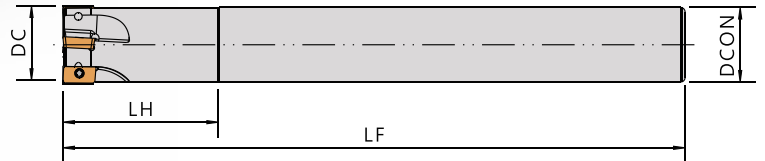

▼Recommended Inserts 建議刀片品牌: DIJET

Order No.	Insert	Dimensions(mm)					Screw	Wrench
		刀徑 DC	長度 LF	頭長 LH	柄徑 DCON	刃數 I No.		
Right / Left								
E90ZC10-1616M2	ZCMT100308R	16	150	25	16	2	CS25065	DT-8
E90ZC10-1616R2		16	200	25	16	2		
E90ZC10-1616S2		16	250	25	16	2		
E90ZC10-1816M2		18	150	25	16	2		
E90ZC10-1816R2		18	200	25	16	2		
E90ZC10-1816S2		18	250	25	16	2		
E90ZC10-2020M3		20	150	25	20	3		
E90ZC10-2020R3		20	200	25	20	3		
E90ZC10-2020S3		20	250	25	20	3		
E90ZC10-2525M4		25	150	32	25	4		
E90ZC10-2525R4		25	200	32	25	4		
E90ZC10-2525S4		25	250	32	25	4		
長頸型 (Long-neck Type)								
E90ZC10-1615M2-40	ZCMT100308R	16	150	40	15	2	CS25065	DT-8
E90ZC10-1616M2-40		16	150	40	16	2		
E90ZC10-1716M2-40		17	150	40	16	2		
E90ZC10-2019Q3-50		20	180	50	19	3		
E90ZC10-2020Q3-50		20	180	50	20	3		
E90ZC10-2120Q3-50		21	180	50	20	3		
E90ZC10-2524R4-50		25	200	50	24	4		
E90ZC10-2525R4-50		25	200	50	25	4		
E90ZC10-2625R4-50		26	200	50	25	4		

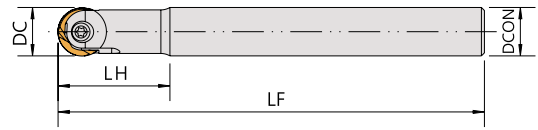
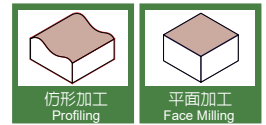

▼ Recommended Inserts 建議刀片品牌: WALTER

Order No.	Insert	Dimensions(mm)				Screw	Wrench
		刀徑 DC	柄徑 DCON	長度 LF	頭長 LH		
MWG08-08A	P32...-D08	8	8	100	25	CSG308/FS397	DBIT-T8
MWG08-08AL				130	30		
MWG08-10A		8	10	110	25		
MWG08-10AL				140	55		
MWG10-10A	P32...-D10	10	10	110	30	CSG410/FS390	DBIT-T15
MWG10-10AL				150	65		
MWG12-12A	P32...-D12	12	12	130	32	CSG512/FS391	DBIT-T20
MWG12-12AL				180	75		
MWG16-16A	P32...-D16	16	16	140	36	CSG516/FS392	DBIT-T20
MWG16-16AL				180	75		
MWG20-20A	P32...-D20	20	20	150	45	CSG520/FS393	DBIT-T20
MWG20-20AL				180	75		
MWG25-25A	P32...-D25	25	25	160	45	CSG625/FS394	DBIT-T20
MWG25-25AL				200	85		
MWG30-32A	P32...-D30	30	32	180	56	CSG830/FS395	DBIT-T30
MWG30-32AL				230	110		
MWG32-32A	P32...-D32	32	32	180	56	CSG830/FS395	DBIT-T30
MWG32-32AL				230	110		



高硬鋼  
Harden alloy steel screw-in holder

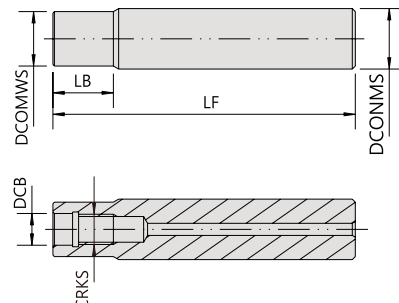
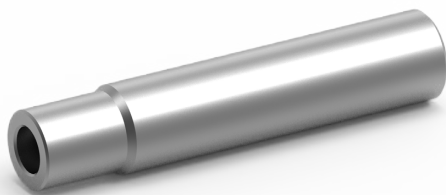

with coolant 有水孔

Order No.	Dimensions(mm)					
	機台夾持柄徑 DCONMS	長度 LF	螺紋 CRKS	連接孔徑 DCB	前端長度 LB	刀具安裝直徑 DCONWS
HML08M04-080	8	80	M4	4.5	8	6
HML08M04-120	8	120		4.5		6
HML10M05-080	10	80	M5	5.5	10	8
HML10M05-120	10	120		5.5		8
HML12M06-100	12	100	M6	6.5	12	10
HML12M06-150	12	150		6.5		10
HML16M08-100	16	100	M8	8.5	16	14
HML16M08-150	16	150		8.5		14
HML20M10-100	20	100	M10	10.5	20	18
HML20M10-150	20	150		10.5		18
HML25M12-100	25	100	M12	12.5	25	23
HML25M12-150	25	150		12.5		23
HML32M16-100	32	100	M16	17	32	30
HML32M16-150	32	150		17		30
HML32M16-200	32	200		17		30